**User's
Manual**

Model UT351-xA
Digital Indicating Controller
with Active Color PV Display and
Embedded Ethernet
User's Manual



IM 05D01D13-41E

Introduction

Thank you for purchasing the UT351 digital indicating controllers.

■ How to Use the Manuals

Purpose	Title	Description
Setup	1. Installation	Describes the tasks (installation, wiring, and others) required to make the controller ready for operations.
Basic operation	2. Initial Settings	Describes examples of setting PV input types, control output types, and alarm types. Making settings described herein allows you to carry out basic control.
Operating procedures and troubleshooting	3. Operations 4.1 Troubleshooting	Describes key operation sequences. For operation control through external contact inputs, see "1.5 Terminal Wiring Diagrams."
Brief operation and setpoint recording	5. Parameters	Contains the parameter map used as a guideline for setting parameters and lists of parameters for recording User Settings.

■ Regarding This User's Manual

- (1) This manual should be provided to the end user. Keep an extra copy or copies of the manual in a safe place.
- (2) Read this manual carefully to gain a thorough understanding of how to operate this product before starting operation.
- (3) This manual describes the functions of this product. Yokogawa Electric Corporation (hereinafter simply referred to as Yokogawa) does not guarantee the application of these functions for any particular purpose.
- (4) Under absolutely no circumstances may the contents of this manual, in part or in whole, be transcribed or copied without permission.
- (5) The contents of this manual are subject to change without prior notice.
- (6) Every effort has been made to ensure that the details of this manual are accurate. However, should any errors be found or important information be omitted, please contact your nearest Yokogawa representative or our sales office.

■ Safety Precautions

The following symbol is indicated on the controller to ensure safe use.



This symbol on the controller indicates that the operator must refer to an explanation in the user's manual in order to avoid the risk of injury or death of personnel or damage to the instrument. The manual describes how the operator should exercise special care to avoid electric shock or other dangers that may result in injury or loss of life.

The following symbols are used in the hardcopy user's manuals and in the user's manual supplied on the CD-ROM.



Indicates that operating the hardware or software in a particular manner may damage it or result in a system failure.



Draws attention to information that is essential for understanding the operation and/or features of the controller.

■ Force Majeure

- (1) Yokogawa assumes no liability to any party for any loss or damage, direct or indirect, caused by the use or any unpredictable defect of the product.
- (2) No portion of the software supplied by Yokogawa may be transferred, exchanged, leased or sublet for use by any third party without the prior permission of Yokogawa.
- (3) Be sure to use the spare parts approved by Yokogawa when replacing parts or consumables.
- (4) Use this software with one specified computer only. You must purchase another copy of the software for use on each additional computer.
- (5) Copying this software for purposes other than backup is strictly prohibited.
- (6) Store the floppy disk(s) (original medium or media) containing this software in a secure place.

■ Regarding Protection, Safety, and Prohibition Against Unauthorized Modification

- (1) In order to protect the product and the system controlled by it against damage and ensure its safe use, make certain that all of the instructions and precautions relating to safety contained in this document are strictly adhered to. Yokogawa does not guarantee safety if products are not handled according to these instructions.
- (2) Modification of the product is strictly prohibited.
- (3) Reverse engineering such as the disassembly or decompilation of software is strictly prohibited.

■ Trademark

“Ethernet” is registered trademark of XEROX Corporation.

Blank Page

Model UT351 with Active Color PV Display and Embedded Ethernet Digital Indicating Controller User's Manual

IM 05D01D13-41E 4th Edition

CONTENTS

Introduction	i
1. Installation	1-1
1.1 Model and Suffix Codes	1-1
1.2 How to Install	1-2
1.3 How to Connect Wires	1-5
1.4 Hardware Specifications	1-7
1.5 Terminal Wiring Diagrams	1-13
2. Initial Settings	2-1
2.1 Names and Functions of Front Panel Parts	2-2
2.2 Setting PV Input Type (Setting First at Power-on)	2-3
2.3 Changing PV Input Type	2-6
2.4 Setting Control Output Type	2-8
2.5 Changing Alarm Type	2-9
2.6 Setting the PV Display Color Changing Function "Active Color PV Display" ...	2-13
2.7 Setting the High Limit and Low limit for PV Color Change	2-14
2.8 Description of Multiple Setpoints and PID	2-14
3. Operations	3-1
3.1 Monitoring-purpose Operating Displays Available during Operation	3-1
3.2 Setting Target Setpoint (SP)	3-3
3.3 Performing/Canceling Auto-tuning	3-4
3.4 Setting PID Manually	3-5
3.5 Setting Alarm Setpoints	3-6
3.6 Selecting Target Setpoint Numbers (SP.NO)	3-7
3.7 Switching between Run and Stop	3-8
3.8 Switching between AUTO and MAN	3-9
3.9 Manipulating Control Output in Manual Operation	3-10
4. Troubleshooting and Maintenance	4-1
4.1 Troubleshooting	4-1
4.2 Maintenance	4-4
4.2.1 Cleaning	4-4
4.2.2 Replacing Brackets	4-4
4.2.3 Replacing Parts with a Limited Service Life	4-4
4.2.4 Replacing Control Output Relays	4-5

5. Parameters	5-1
5.1 Parameter Map	5-1
5.2 Lists of Parameters	5-4
6. Function Block Diagram and Descriptions	6-1
Revision Information	i

1. Installation

This chapter describes installation, wiring, and other tasks required to make the controller ready for operation.

1.1 Model and Suffix Codes

Before using the controller, check that the model and suffix codes match your order.

Model	Suffix Code	Description
UT351		Digital indicating controller (provided with retransmission output and 15 V DC loop power supply as standard)
Type	-0 -2	Standard type Heating/cooling type
Optional functions	A	With Ethernet communication

Check that the following items are provided:

- Digital indicating controller (of ordered model) 1
- Brackets (mounting hardware) 1 pair
- Unit label 1
- User's Manuals 3 (A2 size)
- User's Manuals
Setting/Explanation of Active Color PV Display 1 (A3 size)
- User's Manual (Reference) (CD-ROM version) 1

1.2 How to Install

NOTE

To install the controller, select a location where:

1. no one may accidentally touch the terminals,
2. mechanical vibrations are minimal,
3. corrosive gas is minimal,
4. temperature can be maintained at about 23°C and the fluctuation is minimal,
5. no direct radiant heat is present,
6. no magnetic disturbances are caused,
7. no wind blows against the terminal board (reference junction compensation element),
8. no water is splashed,
9. no flammable materials are around,

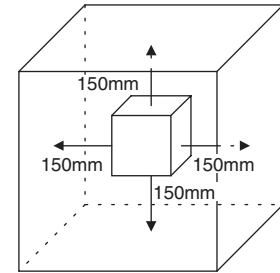

Never place the controller directly on flammable items or equipment.

If the controller has to be installed close to flammable items or equipment, be sure to provide shielding panels all around the controller, at least 150 mm away from every side; the panels should be made of either 1.43 mm-thick metal-plated steel plates or 1.6 mm-thick uncoated steel plates.

NOTE

Never touch the opening at the bottom of the case. It is to be used in the factory at shipping.

● Installation Position

Install the controller at an angle within 30° from horizontal with the front panel facing upward. Do not install it facing downward. The position of right and left sides should be horizontal.

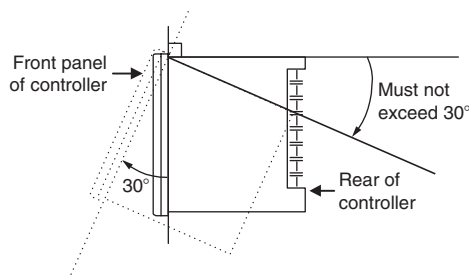

External Dimensions and Panel Cutout Dimensions

UT351

Unit: mm

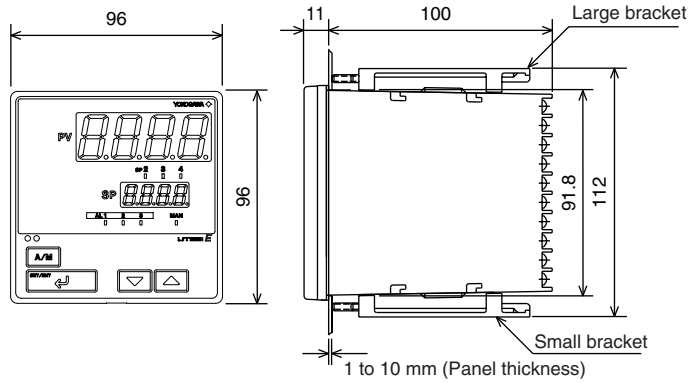

General installation

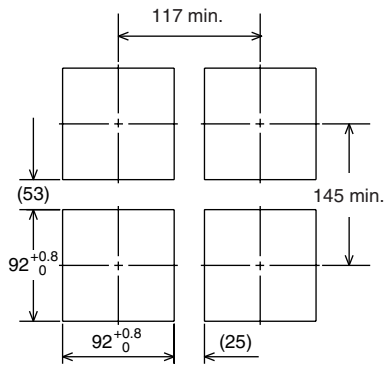

Side-by-side close installation

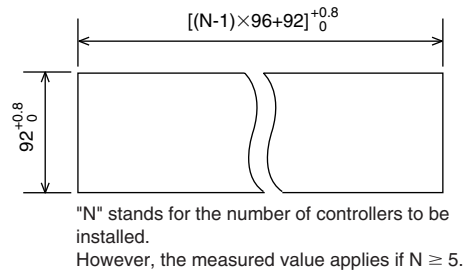

■ How to Install



CAUTION

Turn off the power to the controller before installing it on the panel because there is a possibility of electric shock.

After opening the mounting hole on the panel, follow the procedures below to install the controller:

1. Insert the controller into the opening from the front of the panel so that the terminal board on the rear is at the far side.
2. Set the brackets in place on the top and bottom of the controller as shown in the figure below, then tighten the screws of the brackets. Take care not to overtighten them.

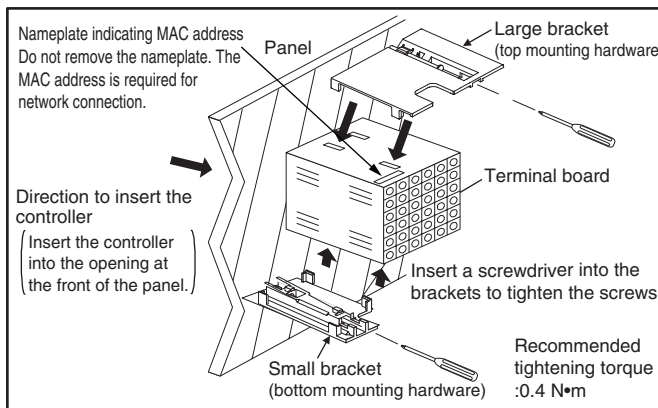

1.3 How to Connect Wires



- 1) Before carrying out wiring, turn off the power to the controller and check that the cables to be connected are not alive with a tester or the like because there is a possibility of electric shock.
- 2) For the protection and safe use of the controller, be sure to place a circuit breaker (conforms with IEC60947, 5A, 100V or 220V AC) near the controller where the breaker can easily be operated. In addition, be sure to indicate that it is the instrument to cut the power supply of the controller.
- 3) Wiring must be carried out by personnel who have basic electrical knowledge and practical experience.



- 1) Provide power from a single-phase instrument power supply. If there is a lot of noise in the power line, insert an insulating transformer into the primary side of the line and use a line filter (recommended part: ZAC2205-00U from TDK) on the secondary side. As a countermeasures against noise, do not place the primary and secondary power cables close to each other.
- 2) For thermocouple input, use shielded compensating lead wires for wiring. For RTD input, use shielded wires that have low conductor resistance and cause no significant differences in resistance between the three wires. The cables to be used for wiring, terminal specifications, and recommended parts are as shown below.
- 3) Control output relays may be replaced. However, because they have a life of 100,000 times that of the resistance load, use auxiliary relays to turn on/off a load.
- 4) The use of inductance (L) loads such as auxiliary relays, motors and solenoid valves causes malfunction or relay failure; always insert a CR filter for use with alternating current or a diode for use with direct current, as a spark-removal surge suppression circuit, into the line in parallel with the load.
- 5) When there is a possibility of being struck by external lightning surge, use the arrester to protect the instrument.

■ For DC Relay Wiring

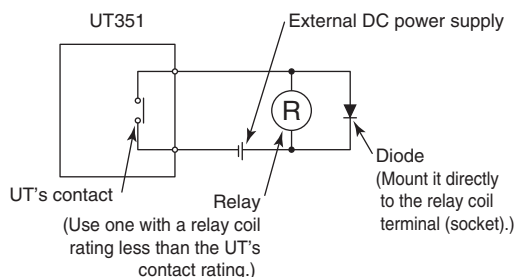

■ For AC Relay Wiring

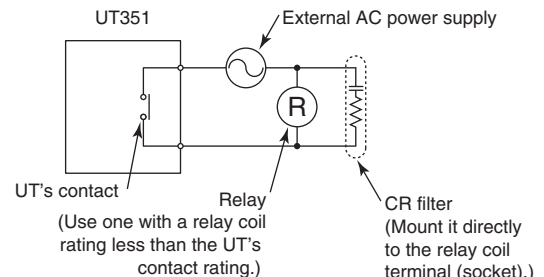

● Cable Specifications and Recommended Cables

Purpose	Name and Manufacturer
Power supply, grounding, relay contact outputs	600 V PVC insulated wires, JIS C 3307, 0.9 to 2.0 mm ²
Thermocouple	Shielded compensating lead wires, JIS C 1610, □X-□-□-□ (See Yokogawa Electric's GS 6B1U1-E.)
RTD	Shielded wires (three conductors), UL2482 (Hitachi Cable)
Other signals	Shielded wires

● Recommended Terminal Lugs

Applicable wire size	Tightening torque
0.3 to 1.65 mm ²	0.8 N·m or less

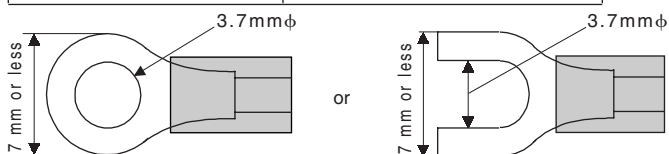

1.4 Hardware Specifications

PV Input Signals

- Number of inputs: 1 (terminals ⑪-⑫-⑬)
- Input type: Universal input system. The input type can be selected with the software.
- Sampling period: 250 ms
- Burnout detection: Functions at TC, RTD, standard signal (0.4 to 2 V or 1 to 5 V)
Upscale, downscale, and off can be specified.
For standard signal, burnout is determined to have occurred if it is 0.1 V or less.
- Input bias current: 0.05 μA (for TC or RTD b-terminal)
- Measurement current (RTD): About 0.13 mA
- Input resistance: 1 M Ω or more for thermocouple or mV input
About 1 M Ω for DC voltage input
- Allowable signal source resistance: 250 Ω or less for thermocouple or mV input
Effects of signal source resistance: 0.1 $\mu\text{V}/\Omega$ or less
2 k Ω or less for DC voltage input
Effects of signal source resistance: About 0.01%/100 Ω
- Allowable wiring resistance: for RTD input
Maximum 150 Ω /wire: Conductor resistance between three wires should be equal
However, 10 Ω /wire for a maximum range of -150.0 to 150.0 $^{\circ}\text{C}$.
Wire resistance effect: $\pm 0.1^{\circ}\text{C}/10 \Omega$
- Allowable input voltage: $\pm 10 \text{ V DC}$ for thermocouple, mV, or RTD input
 $\pm 20 \text{ V DC}$ for DC voltage input
- Noise rejection ratio: 40 dB (50/60 Hz) or more in normal mode
120 dB (50/60 Hz) or more in common mode
- Reference junction compensation error: $\pm 1.0^{\circ}\text{C}$ (15 to 35 $^{\circ}\text{C}$)
 $\pm 1.5^{\circ}\text{C}$ (0 to 15 $^{\circ}\text{C}$, 35 to 50 $^{\circ}\text{C}$)
- Applicable standards: JIS, IEC, DIN (ITS-90) for thermocouples and RTD

Loop Power Supply

Supplies power to a two-wire transmitter.

(15 V DC: terminals ⑭-⑮)

A resistor (10 to 250 Ω) connected between the controller and transmitter converts a current signal into a voltage signal, which is then read via the PV input terminal.

Supply voltage: 14.5 to 18.0 V DC, max. 21 mA (provided with a protection circuit against a field short-circuit)

Retransmission Output

Either PV, target setpoint, or control output is output.

Either the retransmission output or the 15 VDC loop power supply can be used with terminals ⑭-⑮.

- Number of outputs: 1 (terminals ⑭-⑮)
- Output signal: 4-20 mA DC
- Load resistance: 600 Ω or less
- Output accuracy: $\pm 0.3\%$ of span under standard operating conditions (23 $\pm 2^{\circ}\text{C}$, 55 $\pm 10\%$ RH, power frequency of 50/60 Hz)

Control Output

Universal output system, The output type can be selected with the software.

- **Current output**
(Standard type: terminals ⑩-⑪; Heating/cooling type: Heating side: terminals ⑩-⑪; Cooling side: terminals ⑫-⑬)

Number of outputs	1 or 2 (two for heating/cooling type), switched between a voltage pulse output and current output.
Output signal	4-20 mA DC
Load resistance	600 Ω or less
Output accuracy	± 0.3% of span under standard operating conditions (23±2 °C, 55±10% RH, power frequency of 50/60 Hz)

- **Voltage pulse output**
(Standard type: terminals ⑩-⑪; Heating/cooling type: Heating side: terminals ⑩-⑪; Cooling side: terminals ⑫-⑬)

Number of outputs	1 or 2 (two for heating/cooling type), switched between a voltage pulse output and current output.
Output signal	On-voltage = 12 V or more (load resistance: 600 Ω or more) Off-voltage = 0.1 V DC or less
Resolution	10 ms

- **Relay contact output**
(Standard type: terminals ①-②-③; Heating/cooling type: Heating side: terminals ①-②-③; Cooling side: terminals ④-⑦)

Number of outputs	1 or 2 (two for heating/cooling type)
Output signal	Three terminals (NC, NO, and common) / Two terminals
Contact rating	Terminals 1-2-3 : 250 V AC or 30 V DC, 3 A (resistance load) Terminal 4-7 : 240 V AC or 30 V DC, 1A (resistance load)
Resolution	10 ms

Contact Inputs

- Purpose: Selection between target setpoints or Auto/Man modes, or for other purposes
- Number of inputs: 2
- Input type: Non-voltage contact or transistor open collector input
- Input contact rating: 12 V DC, 10 mA or more
- On/off determination: For non-voltage contact input, contact resistance of 1 kΩ or less is determined as “on” and contact resistance of 20 kΩ or more as “off.”
For transistor open collector input, input voltage of 2 V or less is determined as “on” and leakage current must not exceed 100 μA when “off.”
- Minimum status detection hold time: About 1 second.

Contact Outputs

- Purpose: Alarm output, FAIL output, and others
- Number of outputs: 3
- Relay contact rating: 240 V AC/1 A or 30 V DC/1 A (COM terminal is common.)
(FAIL output : 1b)

Display Specifications

- PV display: 4-digit, 7-segment green or red LED display, character height of 20 mm
- Setpoint display: 4-digit, 7-segment red LED display, character height of 9.3 mm
- Status indicating lamps: LEDs

Safety and EMC Standards

- Safety: Complies with IEC/EN61010-1 (CE), approved by C22.2 No.61010-1, approved by UL508.

Installation category : CAT. II Pollution degree : 2 (IEC/EN61010-1, C22.2 No.61010-1)

Measurement category : I (CAT. I : IEC/EN61010-1)

Rated measurement input voltage : 10V DC max.(across terminals), 300V AC max.(across ground)

Rated transient overvoltage : 1500V (Note)

Note : It is a value on the safety standard which is assumed by IEC/EN61010-1 in Measurement category I, and is not the value which guarantees an apparatus performance.



CAUTION

This equipment has Measurement category I, therefore do not use the equipment for measurements within measurement categories II, III and IV.

Measurement category		Description	Remarks
I	CAT. I	For measurements performed on circuits not directly connected to MAINS.	
II	CAT. II	For measurements performed on circuits directly connected to the low voltage installation.	Appliances, portable equipments, etc.
III	CAT. III	For measurements performed in the building installation.	Distribution board, circuit breaker, etc.
IV	CAT. IV	For measurements performed at the source of the low-voltage installation.	Overhead wire, cable systems, etc.

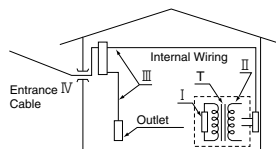

- EMC standards: Complies with EN61326, EN61000-3-2, EN61000-3-3 and EN55011 (CE). AS/NZS 2064 compliant (C-Tick). Class A Group 1.

The instrument continues to operate at a measuring accuracy of within ±20% of the range during tests.

Construction, Installation, and Wiring

- Construction: Dust-proof and drip-proof front panel conforming to IP55. For side-by-side close installation the controller loses its dust-proof and drip-proof protection.
- Material: ABS resin and polycarbonate
- Case color: Black
- Weight: About 1 kg or less
- Dimensions: 96 (W) × 96 (H) × 100 (depth from panel face) mm
- Installation: Panel-mounting type. With top and bottom mounting hardware (1 each)
- Panel cutout dimensions: $92_0^{+0.8}$ (W) × $92_0^{+0.8}$ (H) mm
- Installation position: Up to 30° upward facing (not designed for facing downward)
- Wiring: M3.5 screw terminals (for signal wiring and power/ground wiring as well)

Power Supply Specifications

- Power supply: Rated voltage of 100 to 240 V AC ($\pm 10\%$), 50/60 Hz
- Power consumption: Max. 20 VA (8.0 W max.)
- Internal fuse rating: 250 V AC, 1.6A time-lag fuse
- Data backup: Non-volatile memory (can be written to up to 100,000 times)
- Withstanding voltage
 - Between primary terminals* and secondary terminals**:
At least 1500 V AC for 1 minute
 - Between primary terminals* and grounding terminal:
At least 1500 V AC for 1 minute
 - Between grounding terminal and secondary terminals**:
At least 1500 V AC for 1 minute
 - Between secondary terminals**:
At least 500 V AC for 1 minute
- * Primary terminals indicate power terminals and relay output terminals
- ** Secondary terminals indicate analog I/O signal, voltage pulse output, and contact input terminals
- Insulation resistance: 20 M Ω or more at 500 V DC between power terminals and grounding terminal
- Grounding: Class D grounding (grounding resistance of 100 Ω or less)

Signal Isolations

- PV input terminals: Isolated from other input/output terminals. Not isolated from the internal circuit.
- 15 V DC loop power supply terminals: Not isolated from 4-20 mA analog output and voltage pulse control output. Isolated from other input/output terminals and internal circuit.
- 4-20 mA analog output terminals (for control output and retransmission): Not isolated between 4-20 mA outputs and from 15 V DC loop power supply and voltage pulse control output. Isolated from other input/output terminals and internal circuit.
- Voltage pulse control output terminals: Not isolated from 4-20 mA outputs and 15 V DC loop power supply. Isolated from other input/output terminals and internal circuit.
- Relay contact control output terminals: Isolated between contact output terminals and from other input/output terminals and internal circuit.
- Contact input terminals: Not isolated between contact input terminals and from communication terminals. Isolated from other input/output terminals and internal circuit.
- Relay contact alarm output terminals: Not isolated between relay contact alarm outputs. Isolated from other input/output terminals and internal circuit.
- Ethernet communication terminal: Isolated from internal circuit.
- RS485 communication terminals: Not isolated from contact input terminals. Isolated from other input/output terminals and internal circuit.
- Power terminals: Isolated from other input/output terminals and internal circuit.
- Grounding terminals: Isolated from other input/output terminals and internal circuit.

Environmental Conditions

- Normal operating conditions:
 - Ambient temperature: 0 to 50°C (40°C or less for side-by-side close installation)
 - Temperature change rate: 10°C/h or less
 - Ambient humidity: 20 to 90% RH (no condensation allowed)
 - Magnetic field: 400 A/m or less
 - Continuous vibration at 5 to 14 Hz: Full amplitude of 1.2 mm or less
 - Continuous vibration at 14 to 150 Hz: 4.9 m/s² or less
 - Short-period vibration: 14.7 m/s², 15 seconds or less
 - Shock: 147 m/s² or less, 11 ms
 - Installation height: Height above sea level of 2000 m or less
 - Warm-up time: 30 minutes or more after power on
- Transportation and storage conditions:
 - Temperature: -25 to 70°C
 - Temperature change rate: 20°C/h or less
 - Humidity: 5 to 95% RH (no condensation allowed)
- Effects of changes in operating conditions
 - Effects from changes in ambient temperature:
 - On voltage or thermocouple input, $\pm 1 \mu\text{V}/^\circ\text{C}$ or $\pm 0.01\%$ of F.S./°C, whichever is larger
 - On RTD input, $\pm 0.05^\circ\text{C}/^\circ\text{C}$ (ambient temperature) or less
 - On analog output, $\pm 0.05\%$ of F.S./°C or less
 - Effects from power supply fluctuation (within rated voltage range)
 - On analog input, $\pm 1 \mu\text{V}/10 \text{ V}$ or $\pm 0.01\%$ of F.S./10 V, whichever is larger
 - On analog output, $\pm 0.05\%$ of F.S./10 V or less

1.5 Terminal Wiring Diagrams



NOTE

Do not use unassigned terminals as relay terminals.

Terminal wiring diagrams are shown on and after the next page.

■ UT351 Standard Type (Model UT351-0A)

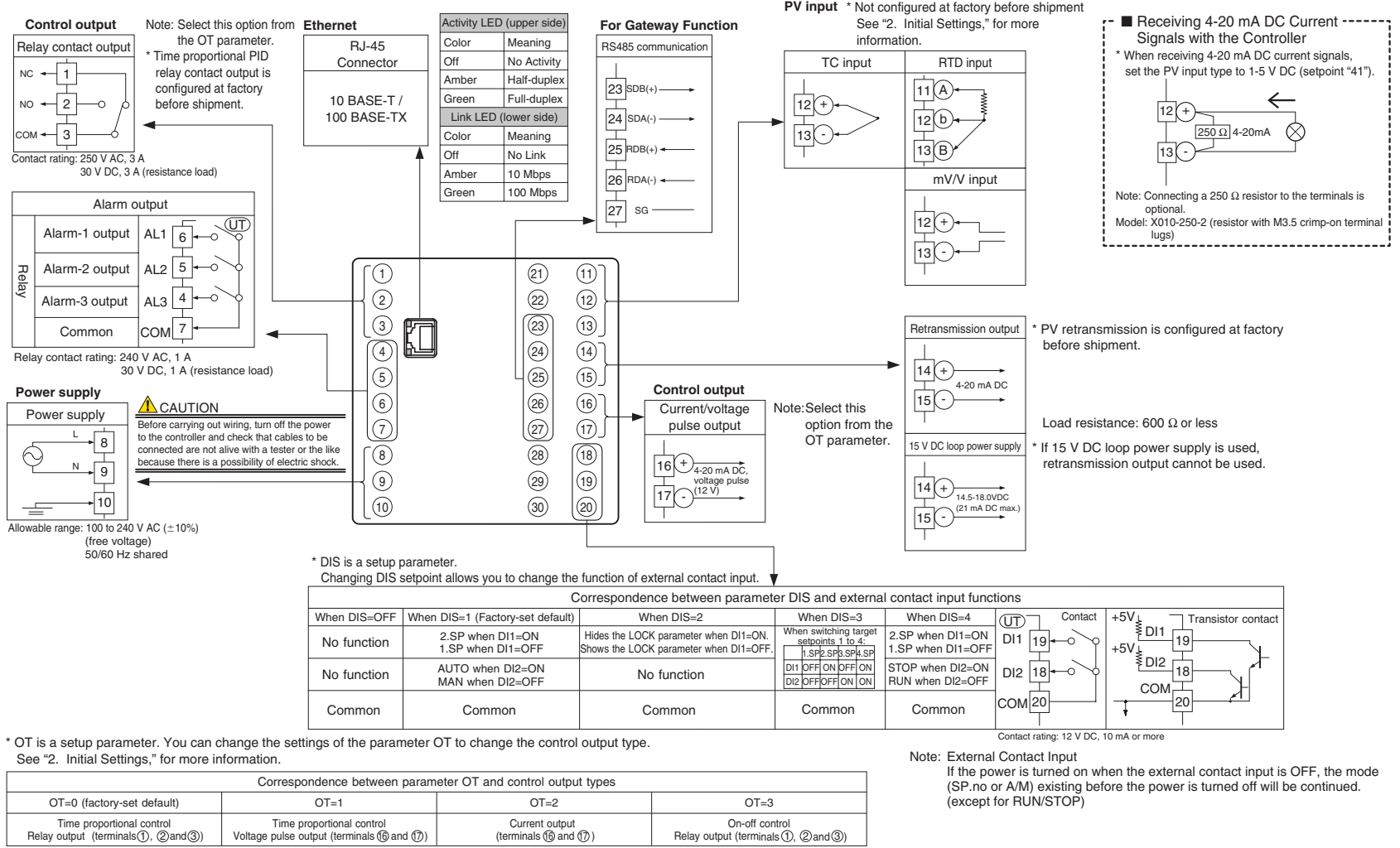

■ UT351 Heating/Cooling Type (Model UT351-2A)

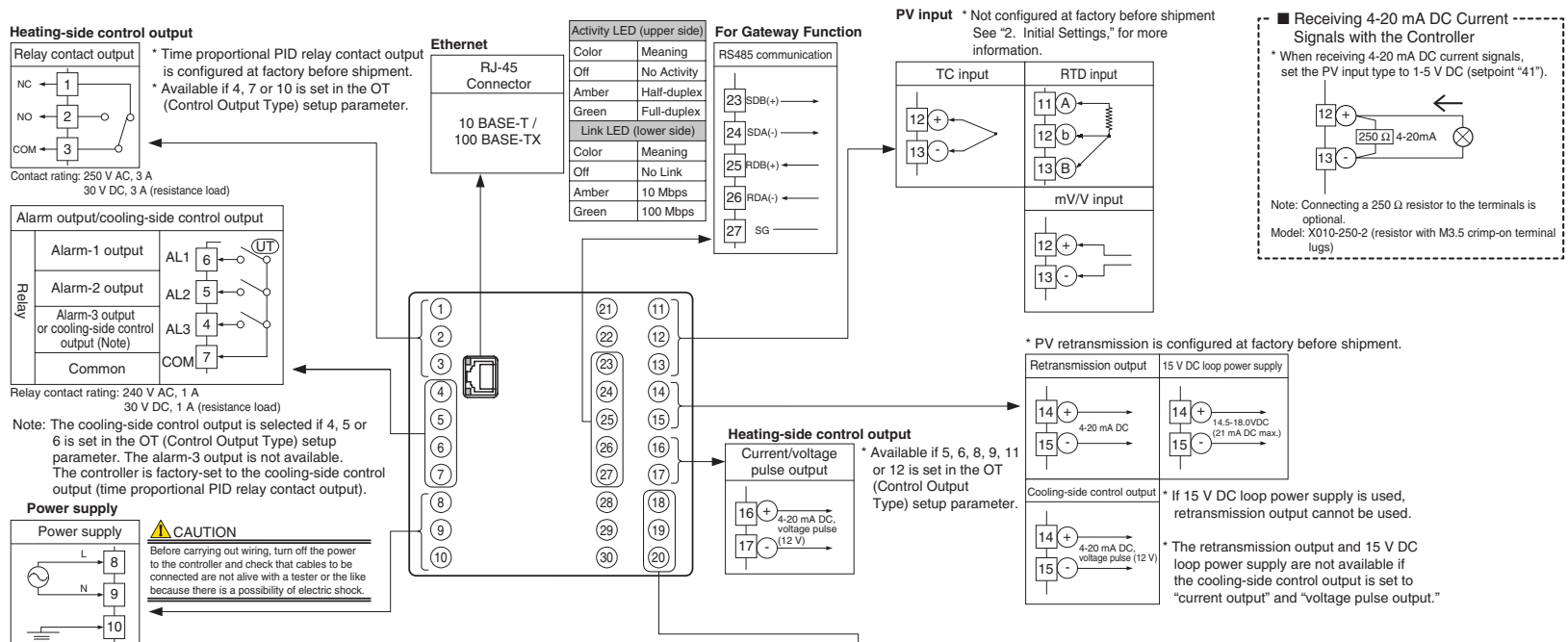

* DIS is a setup parameter. Changing DIS setpoint allows you to change the function of external contact input.

Correspondence between parameter DIS and external contact input functions

When DIS=OFF	When DIS=1 (Factory-set default)	When DIS=2	When DIS=3	When DIS=4
No function	2.SP when DI1=ON 1.SP when DI1=OFF	Hides the LOCK parameter when DI1=ON. Shows the LOCK parameter when DI1=OFF.	When switching target setpoints 1 to 4: 1.SP: SP1, SP4, SP3 DI1 OFF ON OFF ON DI2 OFF OFF ON ON	2.SP when DI1=ON 1.SP when DI1=OFF
No function	AUTO when DI2=ON MAN when DI2=OFF	No function		STOP when DI2=ON RUN when DI2=OFF
Common	Common	Common	Common	Common

Contact rating: 12 V DC, 10 mA or more

Note: External Contact Input
If the power is turned on when the external contact input is OFF, the mode (SP.no or A/M) existing before the power is turned off will be continued. (except for RUN/STOP)

* OT is a setup parameter. You can change the settings of the parameter OT to change the control output type. See "2. Initial Settings," for more information.

Correspondence between parameter OT and heating-side/cooling-side output types

OT=4 (factory-set default)	OT=5	OT=6	OT=7	OT=8	OT=9	OT=10	OT=11	OT=12
Heating side: Relay output (terminals ①, ② and ③) Cooling side: Relay output (terminals ④ and ⑦)	Heating side: Voltage pulse output (terminals ⑥ and ⑦) Cooling side: Relay output (terminals ④ and ⑦)	Heating side: Current output (terminals ⑥ and ⑦) Cooling side: Relay output (terminals ④ and ⑦)	Heating side: Relay output (terminals ①, ② and ③) Cooling side: Voltage pulse output (terminals ④ and ⑤)	Heating side: Voltage pulse output (terminals ⑥ and ⑦) Cooling side: Voltage pulse output (terminals ④ and ⑤)	Heating side: Current output (terminals ⑥ and ⑦) Cooling side: Voltage pulse output (terminals ④ and ⑤)	Heating side: Relay output (terminals ①, ② and ③) Cooling side: Current output (terminals ④ and ⑤)	Heating side: Voltage pulse output (terminals ⑥ and ⑦) Cooling side: Current output (terminals ④ and ⑤)	Heating side: Current output (terminals ⑥ and ⑦) Cooling side: Current output (terminals ④ and ⑤)

The control output types, "relay output" and "voltage pulse output" shown in the table above refer to those of time proportional control. To change the type to a relay output for on-off control, select "Relay Terminals" and change the setpoint of the proportional band to "0."

Blank Page

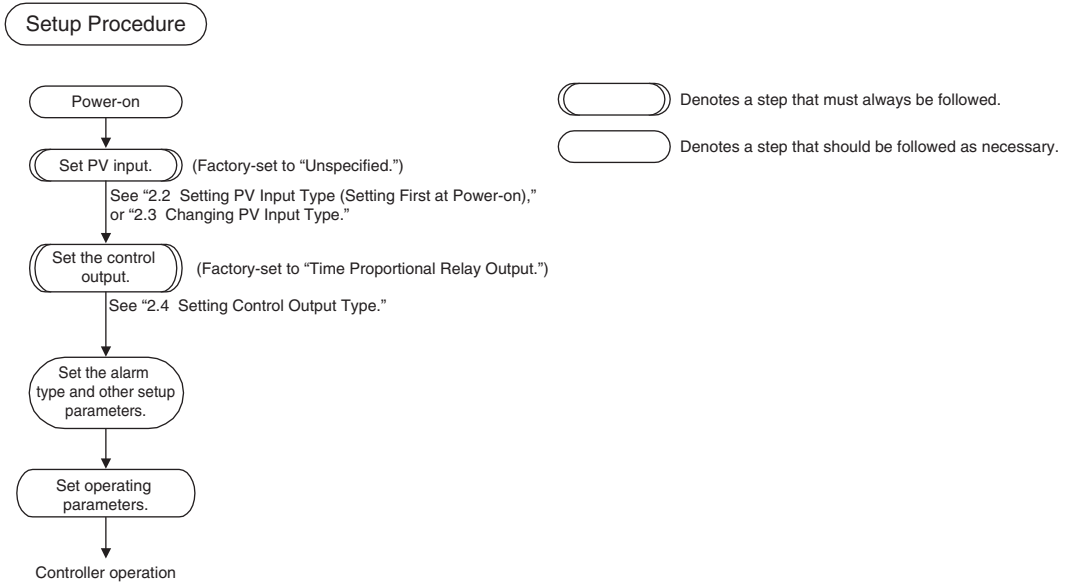

2. Initial Settings

This chapter describes examples of setting PV input types, control output types, and alarm types. Carrying out settings described herein allows you to perform basic control. Refer to examples of various settings to understand how to set parameters required. Refer to “5.1 Parameter Map” for an easy to understand explanation of setting various parameters. If you cannot remember how to carry out an operation during setting, press the  key for more than 3 seconds. This brings you to the display (operating display) that appears at power-on.

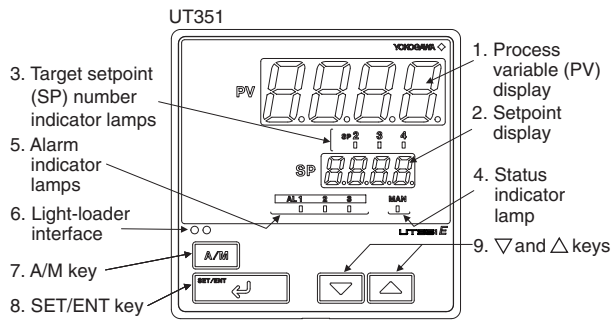

2.1 Names and Functions of Front Panel Parts



Name of Part	Function
1. Process variable (PV) display	Displays PV. Display color can be switched between red and green according to the setting of "PCMD" setup parameter. Displays a parameter symbol when you set a parameter. Displays an error code (in green or red) if an error occurs.
2. Setpoint display	Displays the setpoint (SP) or the output value (OUT) during operation. Displays the set value of parameters on the parameter setting display.
3. Target setpoint (SP) number indicator lamps	When the SP number currently used for operation is 2, 3 or 4, the respective SP No. indicator lamp lights. When the SP number is 1, the lamp does not light.
4. Status indicator lamp	Is lit in green during manual operation. MAN: Is lit when in manual mode. Blinks during auto-tuning.
5. Alarm indicator lamps	If any of alarms 1 to 3 occurs, the respective alarm indicator lamp (AL1 to AL3) is lit (in orange).
6. Light-loader interface	Interface for an adapter cable used when setting and storing parameters from a PC. This requires an optional parameter setting tool.
7. A/M key	 Used to switch between the AUTO and MAN modes. Each time you press the key, it switches to the AUTO or MAN mode alternately.
8. SET/ENT key	 Used to switch or register a parameter. Pressing the key for more than 3 seconds allows you to switch between the operating display and the menu for operating parameter setting display alternately.
9. ▽ and △ keys	 Used to change numerical values. On setting displays for various parameters, you can change target setpoints, parameters, and output values (in manual operation). Pressing the ▽ key decreases a numerical value, while pressing the △ key causes it to increase. You can hold down a key to gradually increase the speed of change.

IMPORTANT



The controller automatically returns to the display at the time of power-on (i.e., operating display) if no key is operated for at least one minute.

■ Setting of Main Parameters at the Factory before Shipment

Item	Factory-set defaults for standard type controllers	Factory-set defaults for heating/cooling type controllers
Control output	Time proportional PID relay output (variable)	Heating side: Time proportional PID relay output (variable) Cooling side: Time proportional PID relay output (variable)
Control action	Reverse action (variable)	Not specified
PID parameter	P = 5.0%, I = 240 seconds, D = 60 seconds.	
Alarm output	Alarm-1: PV high limit, Alarm-2: PV low limit, Alarm-3: PV high limit	

2.2 Setting PV Input Type (Setting First at Power-on)

NOTE

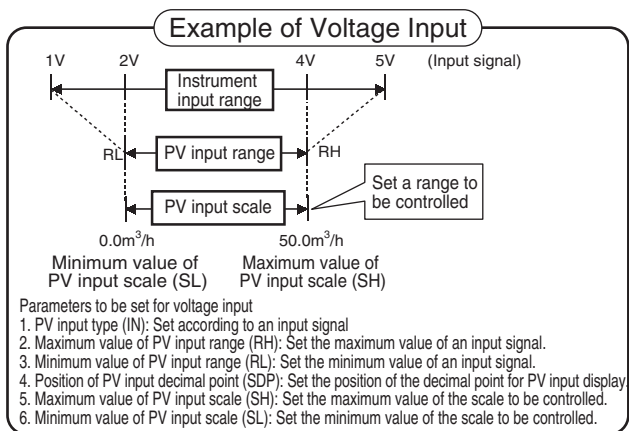
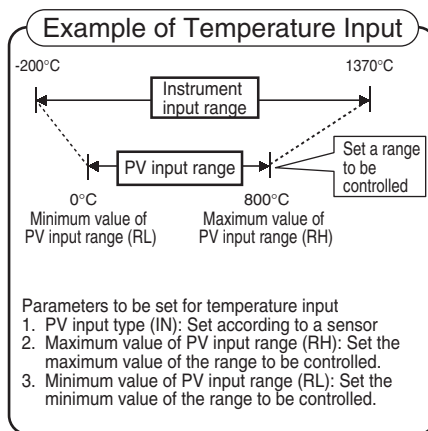

- The controller displays the operating display when the power is turned on. However, if PV input type has not been set, “IN” appears. In this case, first use the  key to display the input range code to use, then press the  key to register it. Then, set the maximum value (RH) and minimum value (RL) of the PV input range (for voltage input, set the maximum value (SH) and minimum value (SL) of the PV input scale).
- The controller is configured to the initial value of each parameter at the factory before shipment. First check the initial values shown in “5.2 Lists of Parameters,” and change parameter values as necessary.

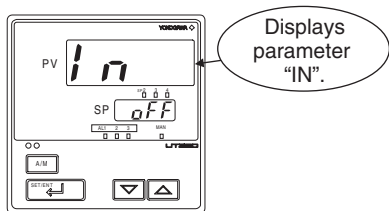

The following operating procedure describes an example of setting the controller to a K-type thermocouple (-199.9°C to 500.0°C) and the measurement range of 0.0°C to 200.0°C.

1. **Display screen at power-on**
The parameter “IN” for setting the PV input type appears.



2. **Press the  or  key to display the required setpoint.**
The figure below is an example of the controller set to a K-type thermocouple (-199.9°C to 500.0°C). See “Instrument Input Range Codes.”

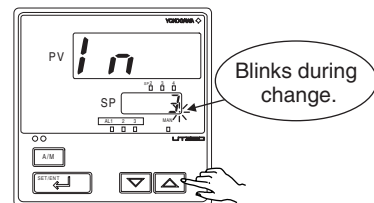

- 3. Press the  key once to register the required setpoint.

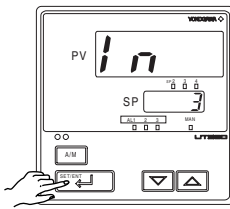

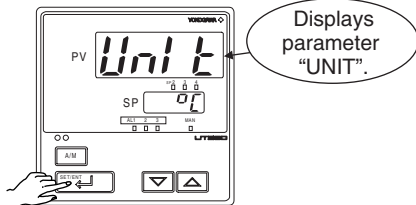

- 4. Press the  key once to display the parameter "UNIT" (PV Input Unit).

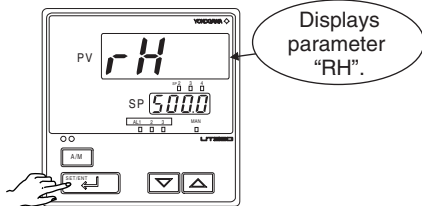

- 5. Press the  key once to display the parameter "RH" (maximum value of PV input range).



- 6. Press the  or  key to display the required setpoint. The figure below shows an example of setting the maximum value of PV input range to 200.0°C.

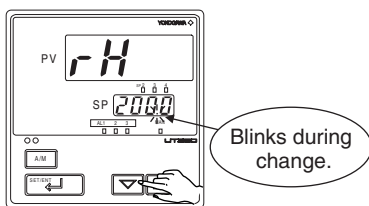

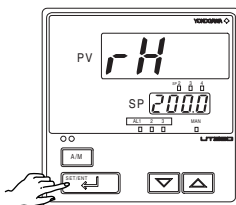

- 7. Press the  key once to register the setpoint.

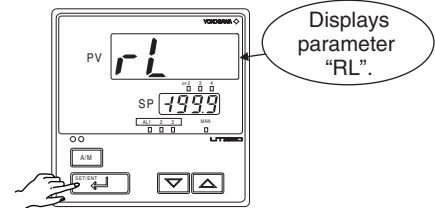

- 8. Press the  key once to display the parameter "RL" (minimum value of PV input range).



- 9. Press the  or  key to display the required setpoint. The figure below shows an example of setting the minimum value of PV input range to 0.0°C.

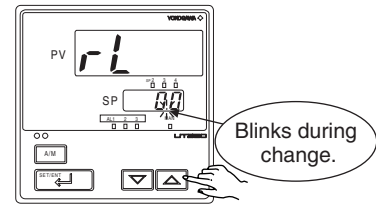

- 10. Press the  key once to register the setpoint.

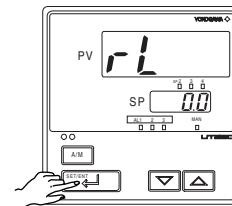

If the type of input is voltage, also configure the PV Input Decimal Point Position (SDP), Maximum Value of PV Input Scale (SH) and Minimum Value of PV Input Scale (SL) that follow this step.

- 11. To set the type of control output, see steps 7 and later in "2.4 Setting Control Output Type." To finish settings, press the  key for more than 3 seconds. This returns you to the display shown at power-on (figure below).

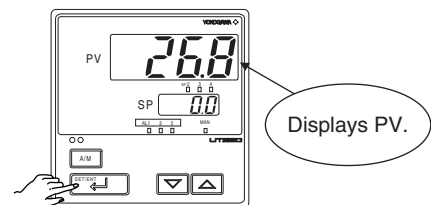

The PV display in the figure above shows the error code for input burnout (*baUt*) if PV input wiring is not yet complete. The error code disappears when you wire the PV input terminals correctly.

Instrument Input Range Codes

Select the unit from the UNIT parameter.

Input	Type	Instrument Input Range Code	Instrument Input Range	Measurement Accuracy	
Unspecified		OFF	Set the data item PV Input Type "IN" to the OFF option to leave the PV input type undefined.		
Thermocouple	K	1	-200 to 1370°C -300 to 2500°F	±0.1% of instrument range ±1 digit for temperatures equal to or higher than 0°C ±0.2% of instrument range ±1 digit for temperatures below 0°C	
		2	-199.9 to 999.9°C 0 to 2300°F		
		3	-199.9 to 500.0°C -199.9 to 999.9°F		
	J	4	-199.9 to 999.9°C -300 to 2300°F		
		5	-199.9 to 400.0°C -300 to 750°F		
	T	6	0.0 to 400.0°C -199.9 to 750.0°F		
		7	0 to 1800°C 32 to 3300°F		±0.15% of instrument range ±1 digit at 400°C or more ±5% of instrument range ±1 digit at less than 400°C
	S	8	0 to 1700°C 32 to 3100°F		±0.15% of instrument range ±1 digit
	R	9	0 to 1700°C 32 to 3100°F		
	N	10	-200 to 1300°C -300 to 2400°F	±0.1% of instrument range ±1 digit ±0.25% of instrument range ±1 digit for temperatures below 0°C	
	E	11	-199.9 to 999.9°C -300 to 1800°F	±0.1% of instrument range ±1 digit for temperatures equal to or higher than 0°C ±0.2% of instrument range ±1 digit for temperatures below 0°C	
	L(DIN)	12	-199.9 to 900.0°C -300 to 1300°F		
	U(DIN)	13	-199.9 to 400.0°C -300 to 750°F	±0.1% of instrument range ±1 digit for temperatures equal to or higher than 0°C ±0.2% of instrument range ±1 digit for temperatures below 0°C	
		14	0.0 to 400.0°C -199.9 to 750.0°F		
	W	15	0 to 2300°C 32 to 4200°F	±0.2% of instrument range ±1 digit	
	Platine1 2	16	0 to 1390°C 32 to 2500°F	±0.1% of instrument range ±1 digit	
	PR20-40	17	0 to 1900°C 32 to 3400°F	±0.5% of instrument range ±1 digit at 800°C or more No accuracy is guaranteed at less than 800°C	
	W97Re3- W75Re25	18	0 to 2000°C 32 to 3600°F	±0.2% of instrument range ±1 digit	
RTD	JPt100	30	-199.9 to 500.0°C -199.9 to 999.9°F	±0.1% of instrument range ±1 digit (Note 1) (Note 2)	
		31	-150.0 to 150.0°C -199.9 to 300.0°F	±0.2% of instrument range ±1 digit (Note 1)	
	Pt100	35	-199.9 to 850.0°C -300 to 1560°F	±0.1% of instrument range ±1 digit (Note 1) (Note 2)	
		36	-199.9 to 500.0°C -199.9 to 999.9°F		
		37	-150.0 to 150.0°C -199.9 to 300.0°F		±0.2% of instrument range ±1 digit (Note 1)
Standard signal	0.4 to 2 V	40	0.400 to 2.000 V	±0.1% of instrument range ±1 digit The read-out range can be scaled between -1999 to 9999.	
	1 to 5 V	41	1.000 to 5.000 V		
DC voltage	0 to 2 V	50	0.000 to 2.000 V		
	0 to 10 V	51	0.00 to 10.00 V		
	-10 to 20 mV	55	-10.00 to 20.00 mV		
	0 to 100 mV	56	0.0 to 100.0 mV		

* Performance in the standard operating condition (at 23±2°C, 55±10%RH, and 50/60Hz power frequency)

Note 1: The accuracy is ±0.3°C of instrument range ±1 digit for a temperature range from 0°C to 100°C.

Note 2: The accuracy is ±0.5°C of instrument range ±1 digit for a temperature ranges from -100°C to 0°C and 100°C to 200°C.

* To receive a 4-20 mA DC signal, select a standard signal of 1 to 5 V DC and connect it to a 250 Ω resistor. This resistor is optional.
Model: X010-250-2 (resistor with M3.5 crimp-on terminal lugs)



NOTE

The controller may automatically initialize the registered operating parameter setpoints if any change is made to the data item PV Input Type (IN), Maximum Value of PV Input Range (RH), Minimum Value of PV Input Range (RL), PV Input Decimal Point Position (SDP), Maximum Value of PV Input Scale (SH) or Minimum Value of PV Input Scale (SL). After a change has been made to any of these data items, be sure to verify the registered operating parameter setpoints to ensure that they are correct. If any data item has been changed to its default, set it to a required value.

2.3 Changing PV Input Type

The following operating procedure describes an example of changing the K-type thermocouple (-199.9°C to 500.0°C) to a Pt100 resistance temperature detector (-199.9°C to 500.0°C) and setting the measurement range of 0.0°C to 200.0°C.

PV input terminal	
Thermocouple/mV/V input.....	⑫-⑬
RTD input	⑪-⑫-⑬

1. Bring the operating display into view (display appears at power on).

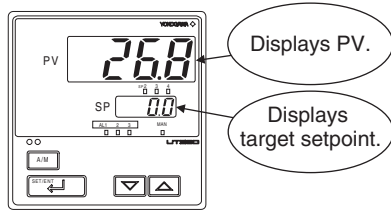

2. Press the **SET/ENT** key for more than 3 seconds to call up the menu "OP.PA".

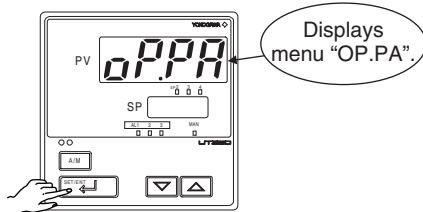

3. Press the **▲** key once to display the menu "STUP".

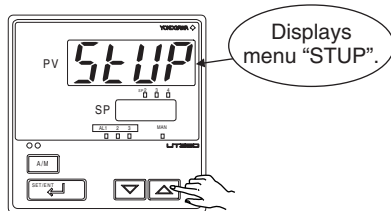

4. Press the **SET/ENT** key once to display the parameter "PWD".

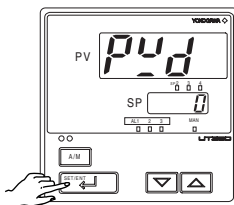

5. Press the **SET/ENT** key once to display the menu "FUNC".

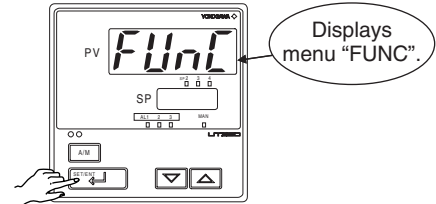

6. Press the **▲** key once to display the menu "I/O".

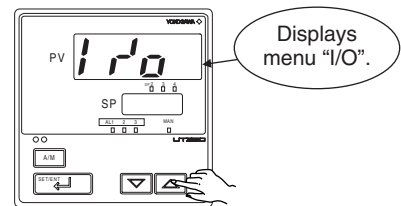

7. Press the **SET/ENT** key once to display the parameter "IN" (PV input type).

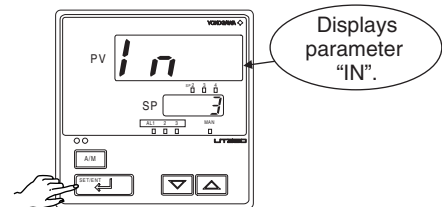

8. Press the **▲** or **▼** key to display the required setpoint. The figure below is an example of the controller set to a Pt 100 resistance temperature detector (-199.9°C to 500.0°C).

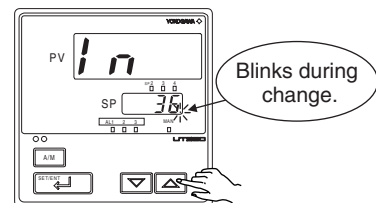

- 9. Press the  key once to register the setpoint.

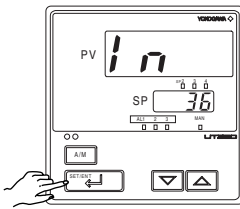

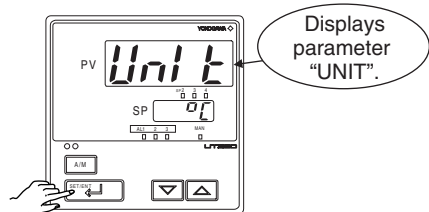

- 10. Press the  key once to display the parameter "UNIT" (PV input unit).

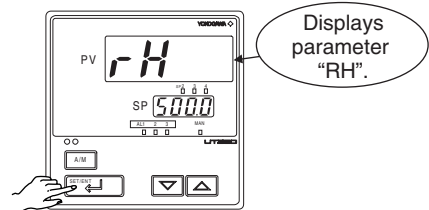

- 11. Press the  key once to display the parameter "RH" (maximum value of PV input range).



- 12. Press the  or  key to display the required setpoint. The figure below shows an example of setting the maximum value of PV input range to 200.0°C.

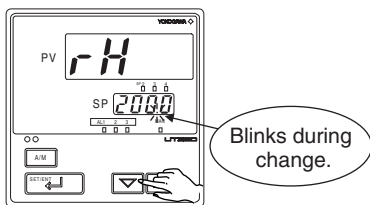

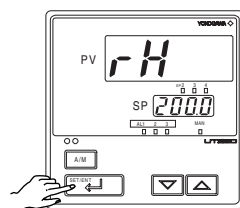

- 13. Press the  key once to register the setpoint.

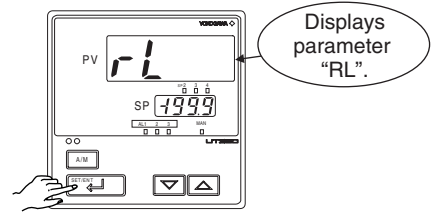

- 14. Press the  key once to display the parameter "RL" (minimum value of PV input range).



- 15. Press the  or  key to display the required setpoint. The figure below shows an example of setting the minimum value of PV input range to 0.0°C.

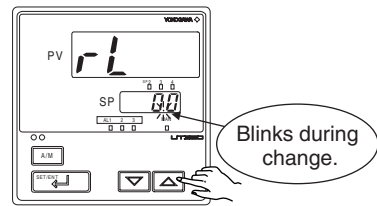

- 16. Press the  key once to register the setpoint.

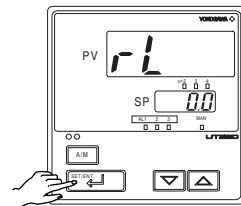

- 17. Press the  key for more than 3 seconds. This returns you to the display shown at power-on (figure below).

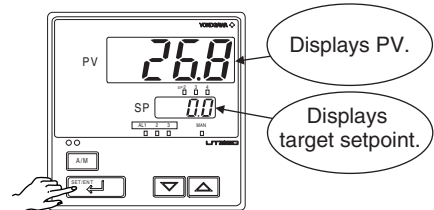

The PV display in the figure above shows the error code for input burnout (*boUt*) if PV input wiring is not yet complete. The error code disappears when you wire the PV input terminals correctly.

2.4 Setting Control Output Type

The following operating procedure describes an example of changing time proportional PID relay output (0: factory-set default) to current output (2).

Control output terminal Values in parentheses are setpoints
 Time proportional PID relay (0)/on-off(3) output..... ①-②-③
 Current (2)/time proportional PID voltage pulse (1) output..... ⑩-⑰
 For details on the heating/cooling control output terminals, see "1.5 Terminal Wiring Diagrams."

1. Bring the operating display into view (display appears at power on).

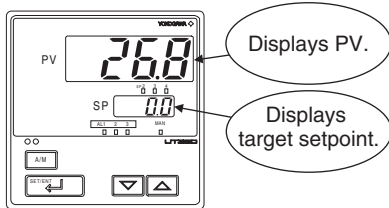

2. Press the **SET/ENT** key for more than 3 seconds to call up the menu "OP.PA".

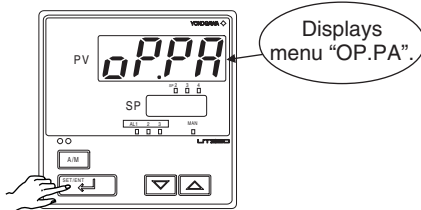

3. Press the **▲** key once to display the menu "STUP".

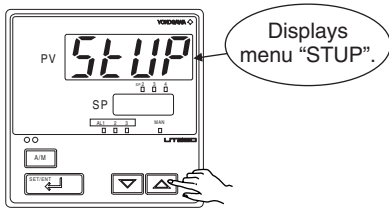

4. Press the **SET/ENT** key once to display the parameter "PWD".

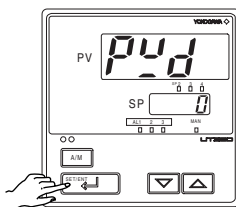

5. Press the **SET/ENT** key once to display the menu "FUNC".

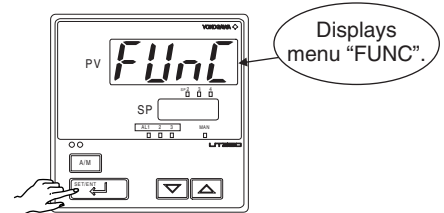

6. Press the **▲** key once to display the menu "I/O".

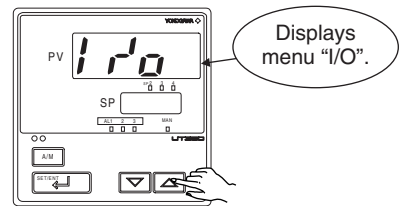

7. Press the **SET/ENT** key several times to display the parameter "OT" (control output type).

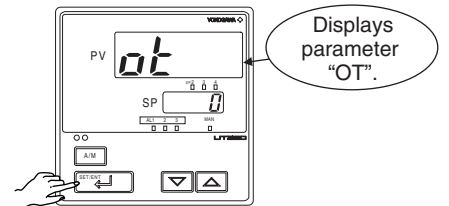

8. Press the **▲** or **▼** key to display the required setpoint. The figure below shows an example of setting to current output (4 to 20 mA DC).

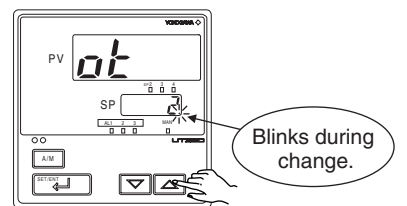

- 9. Press the  key once to register the setpoint.

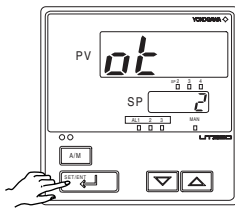

- 10. Press the  key for more than 3 seconds. This returns you to the display shown at power-on (figure below).

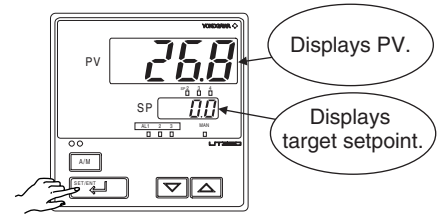

2.5 Changing Alarm Type

The following operating procedure describes an example of changing alarm-1 (factory-set default: PV high limit alarm) to PV low limit alarm. When you have changed alarm type, the alarm setpoint will be initialized; set the alarm setpoint again.

Alarm output terminals	Factory-set defaults
Alarm-1 (terminal numbers ⑥-⑦)PV high limit alarm
Alarm-2 (terminal numbers ⑤-⑦)PV low limit alarm
Alarm-3 (terminal numbers ④-⑦)PV high limit alarm

- 1. Bring the operating display into view (appears at power-on).

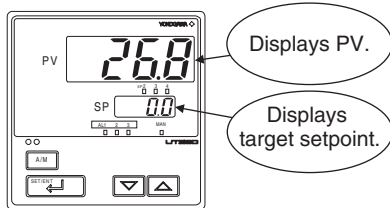

- 3. Press the  key once to display the menu "STUP".

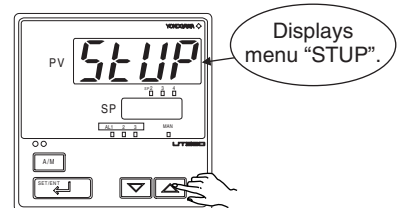

- 2. Press the  key for more than 3 seconds to call up the menu "OP.PA".

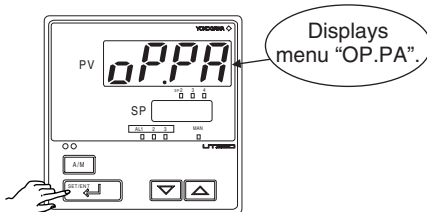

- 4. Press the  key once to display the parameter "PWD".

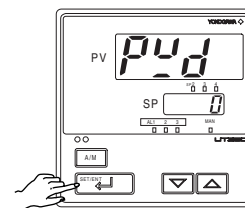

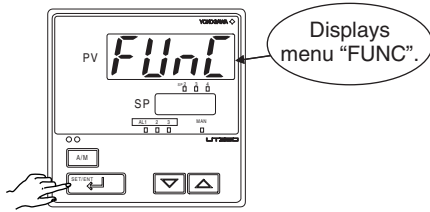

5. Press the  key once to display the menu "FUNC".

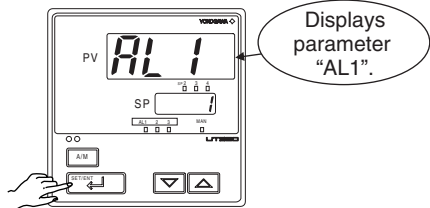

6. Press the  key several times to display the parameter "AL1" (alarm-1 type).



7. Press the  or  key to display the required setpoint. The figure below shows an example of setting PV low limit alarm.

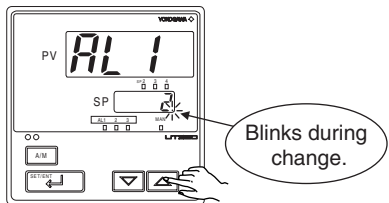

8. Press the  key once to register the setpoint. You can take the same steps for alarm-2 type (AL2), and alarm-3 type (AL3) that are displayed after this.

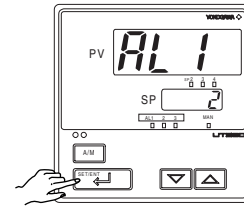

9. Press the  key for more than 3 seconds. This returns you to the display shown at power-on (figure below).

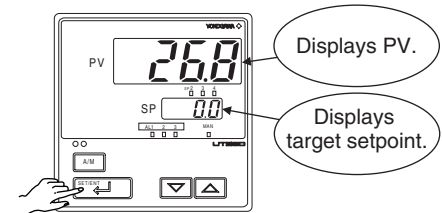

10. When setting an alarm setpoint, see "3.4 Setting Alarm Setpoints."

List of Alarm Types

The table below shows the alarm types and alarm actions.

In the table, codes 1 to 10, 33 to 38 are not provided with stand-by actions, while codes 11 to 20, 43 to 48 are provided with stand-by actions.

Alarm type	Alarm action "Open/close" shows status of relay contact, and "lit" and "unlit" shows status of lamp	Alarm type code		Alarm type	Alarm action "Open/close" shows status of relay contact, and "lit" and "unlit" shows status of lamp	Alarm type code	
		Contact closes if alarm occurs	Contact opens if alarm occurs			Contact closes if alarm occurs	Contact opens if alarm occurs
No alarm		OFF					
PV high limit		1		De-energized on deviation low limit alarm (Note 3)		/	6 16
		11					
PV low limit		2		Deviation high and low limits (Note 3)		/	7 17
		12					
Deviation high limit (Note 3)		3		Deviation within high and low limits (Note 3)		/	8 18
		13					
Deviation low limit (Note 3)		4		De-energized on PV high limit		/	9 19
		14					
De-energized on deviation high limit alarm (Note 3)			5	De-energized on PV low limit		/	10 20
			15				
Fault diagnosis output (Note 1)	Fault diagnosis output		21	/	/	/	/
FAIL output (Note 2)	The controller stops when in a FAIL state. The control output is set to "OFF" or "0%" and alarm output is set to "OFF".		22	/	/	/	/
Sensor grounding alarm	Sensor grounding alarm		23	/	/	/	/
SP high limit			28	Output high limit		/	30
			29				
SP low limit			29	Output low limit		/	31
			30				
Deviation high limit for target setpoint (Note 3)			33	De-energized on deviation low limit alarm for target setpoint (Note 3)		/	36 46
			43				
Deviation low limit for target setpoint (Note 3)			34	Deviation high and low limits for target setpoint (Note 3)		/	37 47
			44				
De-energized on deviation high limit alarm for target setpoint (Note 3)			35	Deviation within high and low limits for target setpoint (Note 3)		/	38 48
			45				





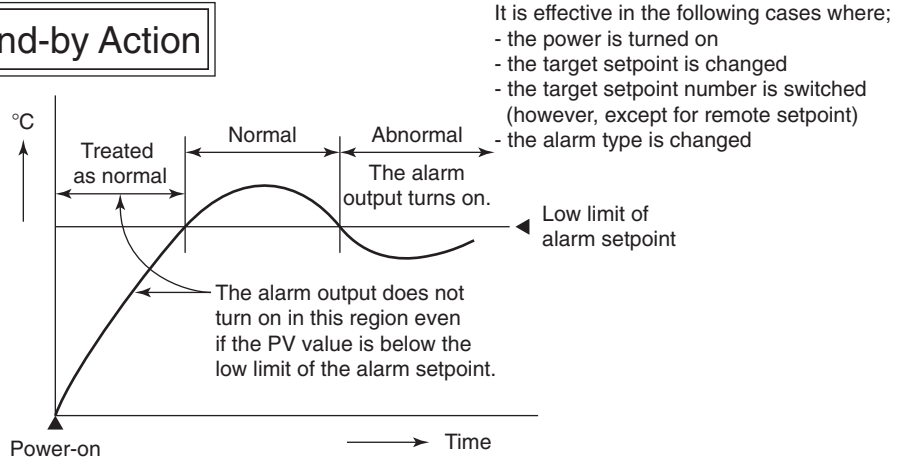





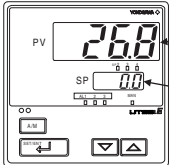

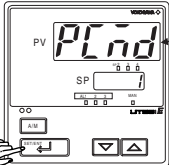

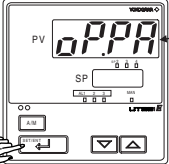

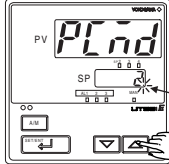
- Note 1: The fault diagnosis output turns on in case of input burnout, A/D converter failure, or reference junction compensation (RJC) failure.
The control output in case of input burnout or A/D converter failure is set to the value of the PO (Preset Output Value) setup parameter. In case of RJC failure, the controller continues control under the condition of "RJC = OFF".
- Note 2: The FAIL output is on during normal operation and turns off in case of failure.
- Note 3: The difference of alarm action between the alarm type codes 3 to 8, 13 to 18 and 33 to 38, 43 to 48 in the table above is as follows.
The codes 3 to 8, 13 to 18 are effective for current setpoints. (For example, they are effective for the ramp rate setpoint at SP switching.)
The codes 33 to 38, 43 to 48 are effective for target setpoints. (For example, they are not effective for the ramp rate setpoint at SP switching.)

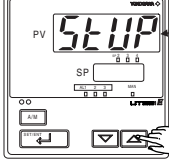
Stand-by Action

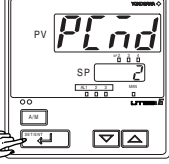

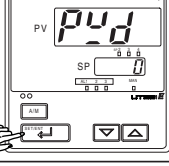

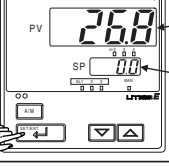

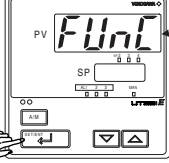



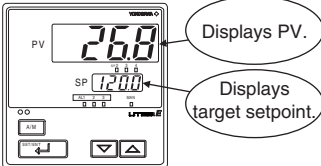

2.6 Setting the PV Display Color Changing Function “Active Color PV Display”

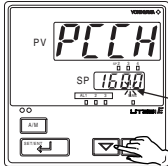
The following operating procedure describes an example of changing the PV color mode (factory-set default : Fixed in red mode) to Link to alarm 1 mode.

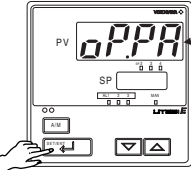
<p>(1) Bring the operating display into view (appears at power on).</p>  <p>Displays PV.</p> <p>Displays target setpoint</p>	<p>(6) Press the  key several times to display the menu “PCMD” (PV color mode).</p>  <p>Displays parameter “PCMD”</p>
<p>(2) Press the  key for more than 3 seconds to call up the menu “OP.PA.”</p>  <p>Displays menu “OP.PA.”</p>	<p>(7) Press the  key or  key to display the required setpoint. The figure below shows an example of setting Link to alarm 1 mode.</p>  <p>Blinks during change</p>
<p>(3) Press the  key once to display the menu “STUP.”</p>  <p>Displays menu “STUP.”</p>	<p>(8) Press the  key once to register the setpoint.</p>  <p>If PCMD = 6, 7, 8 or 9, also set the relating parameters PCCH (High limit for PV color change) and PCCL (Low limit for PC color change).</p>
<p>(4) Press the  key once to display the parameter “PWD.”</p> 	<p>(9) Press the  key for more than 3 seconds. This returns you to the display shown at power-on (figure blow).</p>  <p>Displays PV.</p> <p>Displays target setpoint.</p>
<p>(5) Press the  key once to display the menu “FUNC.”</p>  <p>Displays menu “FUNC.”</p>	

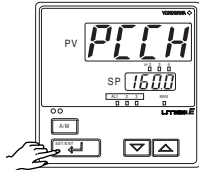
2.7 Setting the High Limit and Low limit for PV Color Change

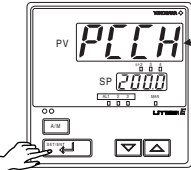
The following operating procedure describes an example of changing PV display color by PV limit(s). Set the High limit and / or Low limit for PV color change.

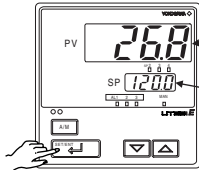
<p>(1) Bring the operating display into view (appears at power-on).</p> 	<p>(4) Press the  key or  key to display the required setpoint.</p> 
<p>(2) Press the  key for more than 3 seconds to call up the menu "OP.PA."</p> 	<p>(5) Press the  key once to register the setpoint.</p> 
<p>(3) Press the  key several times to display the parameter "PCCH."</p> 	<p>(6) Press the  key for more than 3 seconds. This returns you to the display shown at power-on (figure below).</p> 

2.8 Description of Multiple Setpoints and PID

The UT351-xA controllers have a maximum of four target setpoint (SP) parameters and has PID for each of these setpoints. The following shows the correspondence between the target setpoint numbers (SP.NO), target setpoints (SP), and PID parameters.

For example, if you have set "2" to the target setpoint number (SP.NO), the control parameters available are target setpoint (2.SP), proportional band (heating-side proportional band) (2.P), integral time (heating-side integral time) (2.I), derivative time (heating-side derivative time) (2.D), cooling-side proportional band (2.Pc), cooling-side integral time (2.Ic), and cooling-side derivative time (2.Dc).

To use multiple target setpoints, see the table below to check the corresponding parameters.

Target setpoint number (SP.NO)	Target setpoint (SP)	PID parameter					
		Proportional band (heating-side proportional band)	Integral time (heating-side integral time)	Derivative time (heating-side derivative time)	Cooling-side proportional band	Cooling-side integral time	Cooling-side derivative time
SP.NO=1	1.SP	1.P	1.I	1.D	1.Pc	1.Ic	1.Dc
SP.NO=2	2.SP	2.P	2.I	2.D	2.Pc	2.Ic	2.Dc
SP.NO=3	3.SP	3.P	3.I	3.D	3.Pc	3.Ic	3.Dc
SP.NO=4	4.SP	4.P	4.I	4.D	4.Pc	4.Ic	4.Dc

3. Operations

This chapter describes key entries for operating the controller. For operations using external contact inputs, see “1.5 Terminal Wiring Diagrams.” If you cannot remember how to carry out an operation during setting, press the  key for more than 3 seconds. This brings you to the display (operating display) that appears at power-on.

NOTE

Do not use the instrument generating strong magnetic field such as radio equipment and the like near the controller. This may cause the fluctuation of the PV value.

3.1 Monitoring-purpose Operating Displays Available during Operation

The monitoring-purpose operating displays available during operation are roughly classified into two groups depending on the types of controller. One group is operating displays for a standard controller and the other group is operating displays for a heating/cooling controller.

■ Operating Displays for a Standard Controller

● SP Display

The PV input value appears on the PV display.

The target setpoint (1.SP) appears on the Setpoint display.

● OUT Display

The PV input value appears on the PV display.

The control output value (OUT) appears on the Setpoint display.

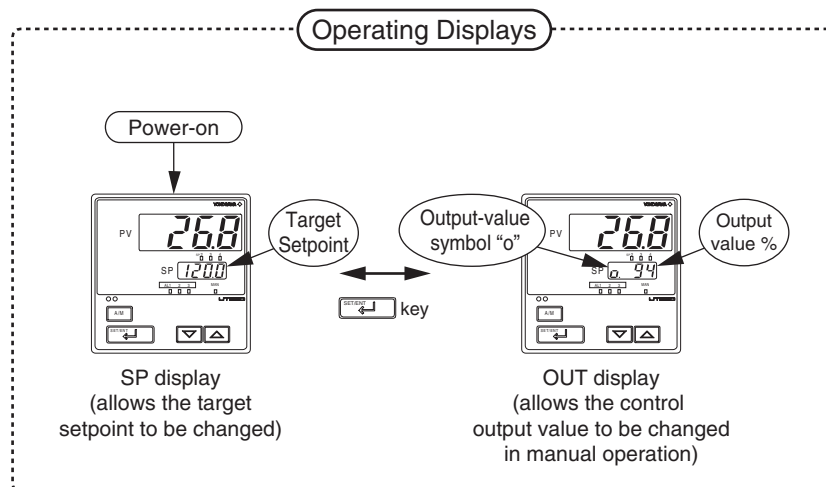

■ Operating Displays for a Heating/Cooling Controller

● SP Display

The PV input value appears on the PV display.

The target setpoint (1.SP) appears on the Setpoint display.

● Heating/Cooling OUT Display

The PV input value appears on the PV display.

The heating (H) and cooling (C) sides control output values appears on the Setpoint display.

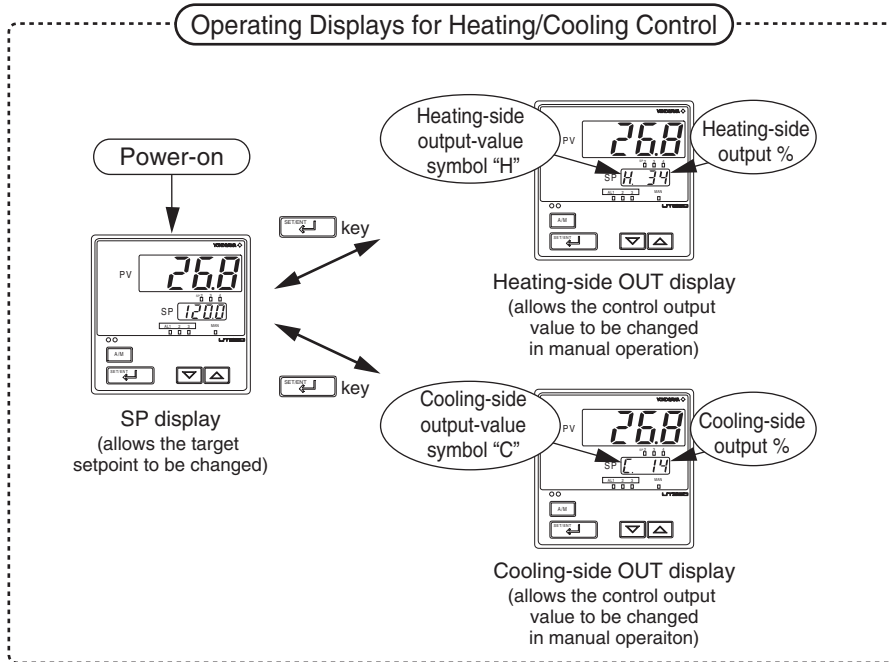

3.2 Setting Target Setpoint (SP)

The following operating procedure describes an example of setting 120.0 to a target setpoint. In automatic operation, the controller starts control using set target setpoints.

 **NOTE**

When the target setpoint is set through communication, the target setpoint cannot be changed by keystroke.

1. Bring the operating display into view (display appears at power on).

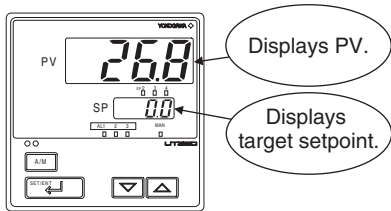

2. Press the  or  key to display the required setpoint.

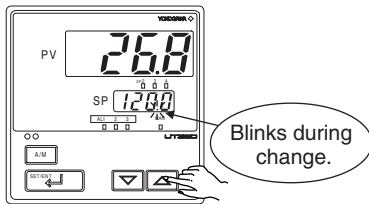

3. Press the  key once to register the setpoint.

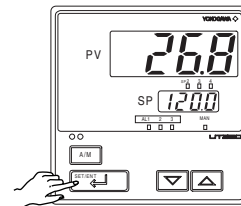

3.3 Performing/Canceling Auto-tuning

Auto-tuning should be carried out after setting a target setpoint (SP). Make sure the controller is in automatic operation mode (AUTO) and running state (RUN) before carrying out auto-tuning. See “3.8 Switching between AUTO and MAN,” to change to AUTO and “3.7 Switching between Run and Stop,” to change to Run.

 **NOTE**

When on-off control is being used, auto-tuning cannot be carried out. Moreover, do not perform auto-tuning when controlling any of the following processes.

- Control processes with quick response such as flow control or pressure control
- Processes where even temporary output on/off results in inconvenience
- Processes where a large output change at control element results in inconvenience
- Processes where variations in PV may exceed an allowable range, adversely affecting product quality

1. Bring the operating display into view (display appears at power on).

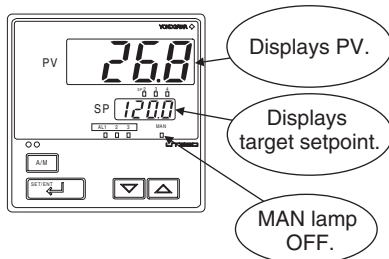

2. Press the  key for **more than 3 seconds** to call up the menu “OP.PA”.

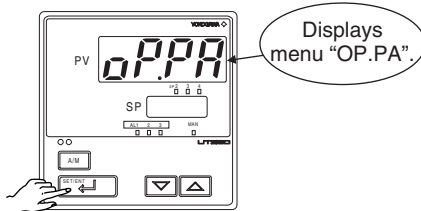

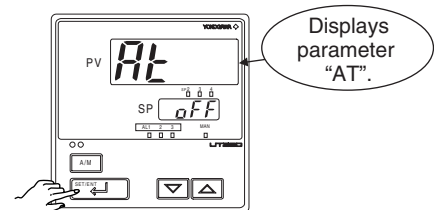

3. Press the  key five times to display the parameter “AT”.

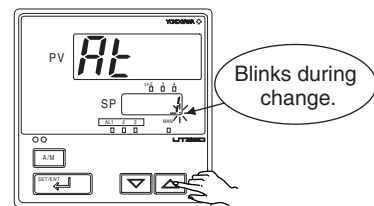

4. Press the  or  key to display the required setpoint. Tuning for 1.SP is AT = 1.



To cancel auto-tuning, set AT = OFF.

5. Press the  key once to register the setpoint. (This starts auto-tuning.)
If the  key is pressed when AT = OFF, auto-tuning will be cancelled. In this case, PID contains the value existing before auto-tuning.

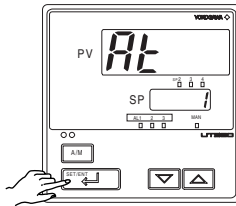

6. During auto-tuning, the panel indications become as shown below.

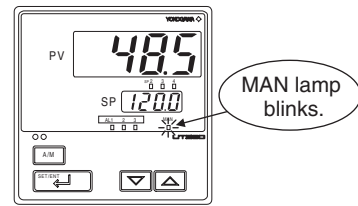

Auto-tuning is complete when the MAN lamp goes off.

3.4 Setting PID Manually

If you know the values to be set or if suitable PID constants cannot be obtained by auto-tuning, follow the procedure below to set values.

1. Bring the operating display into view (display appears at power on).

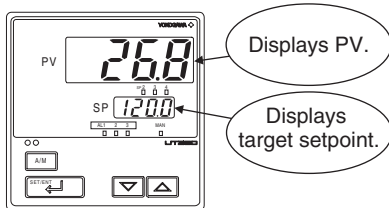

2. Press the  key for more than 3 seconds to call up the menu "OP.PA".

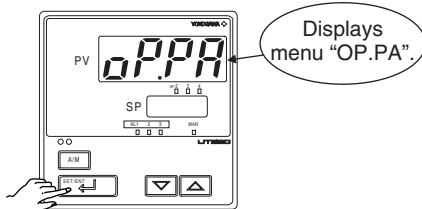

3. Press the  key several times to display the parameter "PID".

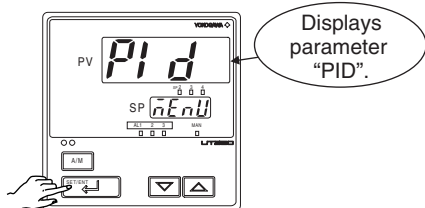

4. Press the  key once to display "1Gr".

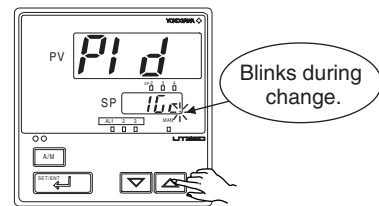

5. Press the  key once to register the setpoints.

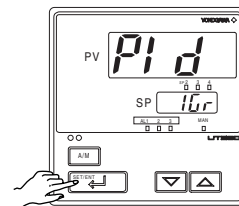

6. Press the  key once to display the parameter "1.P" (proportional band for 1.SP).

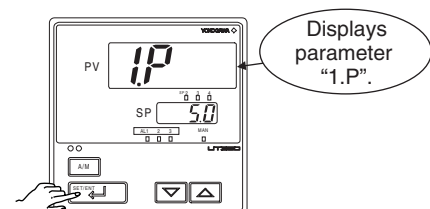

- 7. Press the  or  key to display the required setpoint.

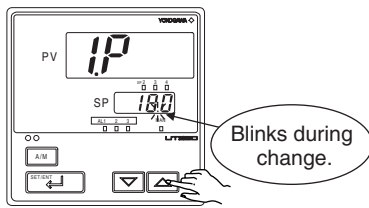

- 8. Press the  key once to register the setpoint.

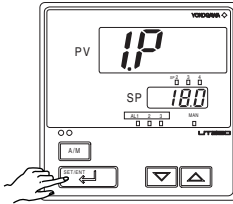

The same steps can be used for integral time (1.I) and derivative time (1.D) that are displayed after this.

[TIP]
The PID parameter numbers set in step 4 should be set as follows:

- In case of PID for 1.SP, PID = 1Gr
- In case of PID for 2.SP, PID = 2Gr
- In case of PID for 3.SP, PID = 3Gr
- In case of PID for 4.SP, PID = 4Gr

- 9. Press the  key for more than 3 seconds. This returns you to the display shown at power-on (figure below).

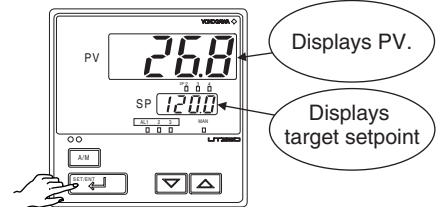

3.5 Setting Alarm Setpoints

The following operating procedure describes an example of setting 160.0 to alarm-1 setpoint. Check alarm type before setting the alarm setpoint. To change the type of alarm, see “2.5 Changing Alarm Type.”

Alarm output terminals	Factory-set defaults
Alarm-1 (terminal numbers ⑥-⑦)	PV high limit alarm
Alarm-2 (terminal numbers ⑤-⑦)	PV low limit alarm
Alarm-3 (terminal numbers ④-⑦)	PV high limit alarm

- 1. Bring the operating display into view (display appears at power on).

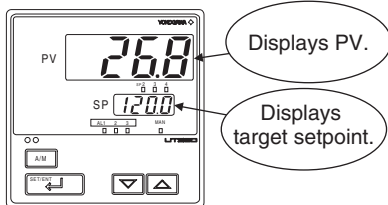

- 2. Press the  key for more than 3 seconds to call up the menu “OP.PA”.

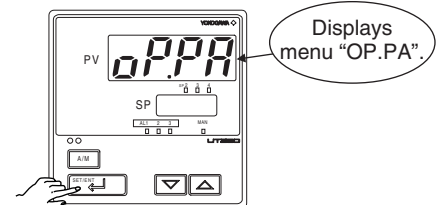

- 3. Press the  key twice to display the parameter "A1".

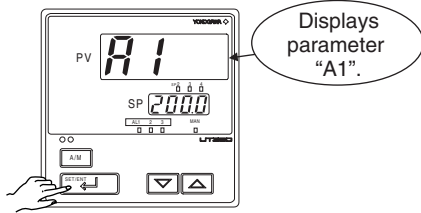

- 4. Press the  or  key to display the required setpoint.

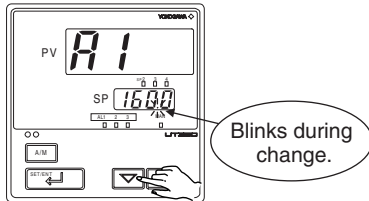

- 5. Press the  key once to register the setpoint.

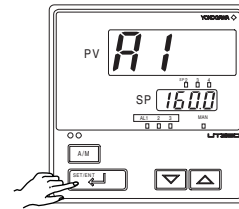

Also configure the Alarm-2 Setpoint (A2) and Alarm-3 Setpoint (A3) parameters that follow this step.

- 6. Press the  key for more than 3 seconds. This returns you to the display shown at power-on (figure below).

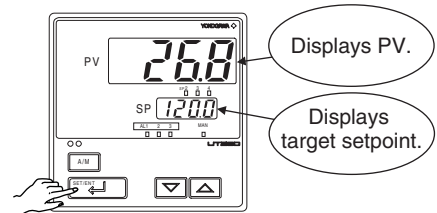

3.6 Selecting Target Setpoint Numbers (SP.NO)

The following operating procedure describes an example of changing a target setpoint number (SP.NO) from 1 to 2.

 **NOTE**

If a target setpoint number has been switched using contact input, when the contact input is on, that number cannot be selected by keystroke.

When using target setpoint ramp setting function, PV tracking works if the target setpoint number is switched.

- 1. Bring the operating display into view (display appears at power on).

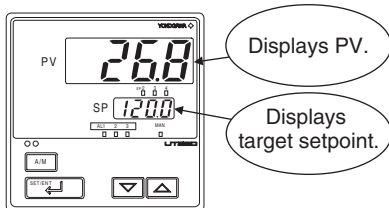

- 2. Press the  key for more than 3 seconds to call up the menu "OP.PA".

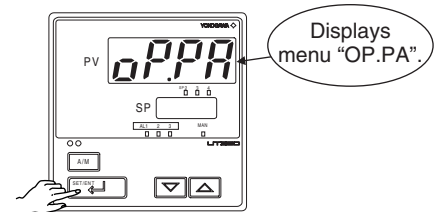

- 3. Press the  key several times to display the parameter "SP.NO".

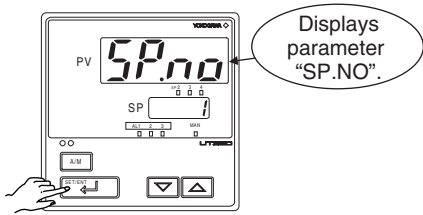

- 4. Press the  or  key to display the required setpoint.

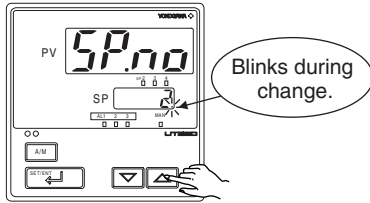

- 5. Press the  key once to register the setpoint.

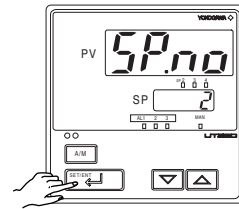

- 6. Press the  key for more than 3 seconds. This returns you to the display shown at power-on (figure below).

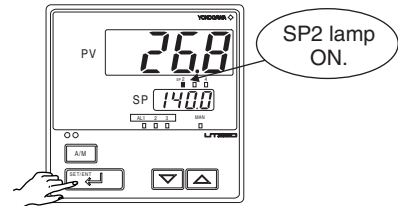

3.7 Switching between Run and Stop

Switching between the RUN and STOP states can be performed only using external contact input.

 **NOTE**

When the controller is shipped from the factory, it is configured so that switching between the RUN and STOP states cannot be performed. To make the switching possible, configure the DIS setup parameter as "DIS = 4".

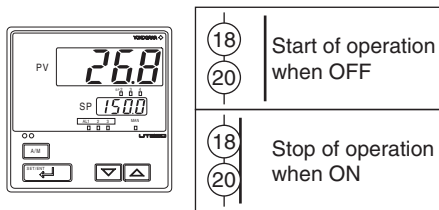

When the controller is stopped, input and outputs are as follows:

PV input	Displays PV.
Control output	Preset output value (factory-set default: 0%)
Alarm output	ON in the event of an alarm

When the controller is stopped, control output display is "StoP".

3.8 Switching between AUTO and MAN

NOTE

If AUTO and MAN have been switched using contact input, when the contact input is ON, switching between AUTO and MAN cannot be achieved by keystroke.

1. Bring the operating display into view (display appears at power on).

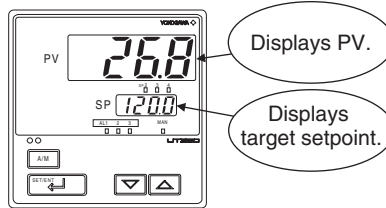

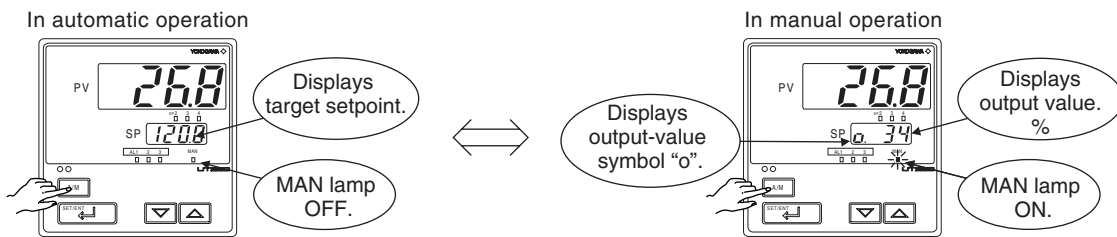

2. Each time you press the **MAN** key on the front panel of the instrument, AUTO and MAN is switched alternately.



3.9 Manipulating Control Output in Manual Operation



NOTE

Control output cannot be changed if the controller is stopped. In this case, the preset output value (setup parameter PO) will be output.

A control output value is linked with a display value changed using the  or  key. Note that the control output changes as displayed without requiring the  key.

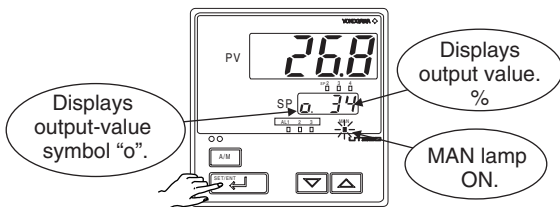
1. Bring manual operating display into view. For switching to manual operation, see “3.8 Switching between AUTO and MAN.”



2. Press the  or  key to change a control output value. You don't need to press the  key.

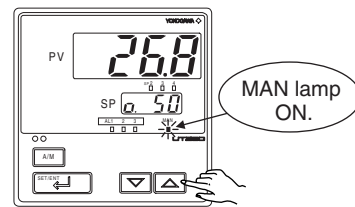

■ Manipulating the Control Output during Heating/Cooling Control

Either of the following two displays appears when the mode is switched to MAN during heating/cooling control.

- Heating-side OUT display

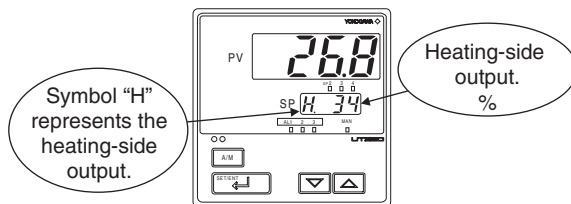



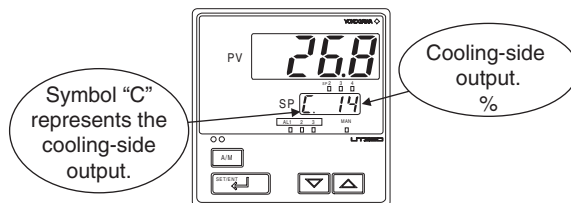

- Cooling-side OUT display



● **Controller Behavior and Control Output Manipulation when the Dead Band is Positive**

The following is an example when the DB parameter is set at 12.4%.

If you hold down the  key with the heating-side output under manipulation (i.e., cooling-side output C = 0.0%), the heating-side output (H =) decreases. Consequently, both the heating-side and cooling-side outputs change to 0.0%. If you keep the  key held down longer, you enter the state of manipulating the cooling-side output, and its value begins to increase.

Inversely, if you hold down the  key with the cooling-side output under manipulation (i.e., heating-side output H = 0.0%), the cooling-side output (C =) decreases. Consequently, both the heating-side and cooling-side outputs go to 0.0%. If you keep the  key held down longer, you enter the state of manipulating the heating-side output, and its value begins to increase.

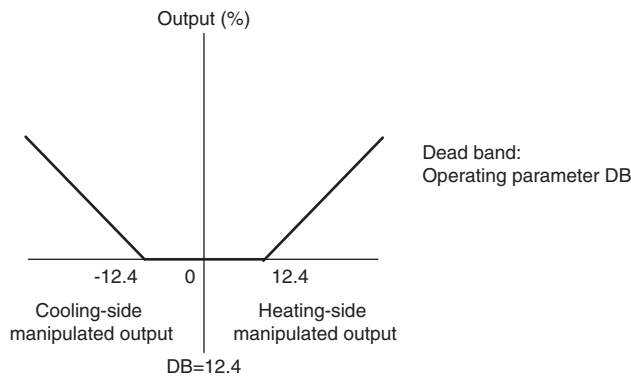

Change in manipulated output when the dead band is positive

Blank Page

4. Troubleshooting and Maintenance

4.1 Troubleshooting

■ Troubleshooting Flow

If the operating display does not appear after turning on the controller's power, follow the measures in the procedure below.

If a problem appears complicated, contact our sales representative.

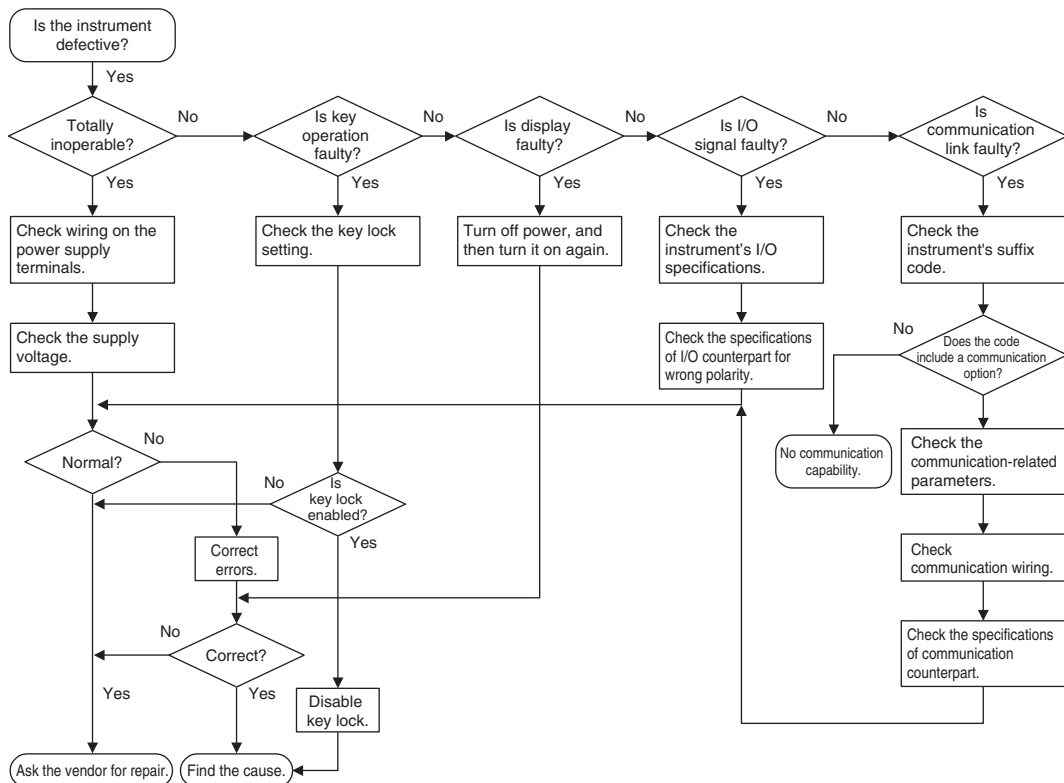

IMPORTANT

Take note of the parameter settings when asking the vendor for repair.

■ Errors at Power on

The following table shows errors that may be detected by the fault diagnosis function when the power is turned on.

Error indication (on PV display unit)	Description of error	PV	Control output	Alarm output	Retransmission output	Communication	Remedy
<i>E000</i> (E000)	Faulty RAM	None	0% or less or OFF	OFF	0% or less	Stopped	Faulty Contact us for repair.
<i>E001</i> (E001)	Faulty ROM						
<i>E002</i> (E002)	System data error	0%					
PV decimal point blinks. 	Faulty calibration value	Normal action (out of accuracy)	Normal action (out of accuracy)	Normal action (out of accuracy)	Normal action (out of accuracy)	Normal action	Check and set the parameters, as they have been set to the limited values.
<i>E400</i> (E400)	Parameter error	0%	Preset value output	OFF	0%		

■ Possible Errors during Operation

The following shows possible errors occurring during operations.

Error indication (on PV display unit)	Description of error	PV	Control output	Alarm output	Retransmission output	Communication	Remedy
Displays "RJC" and PV alternately	RJC error	Measured with RJC=OFF	Normal action	Normal action	Normal action	Normal action	Faulty Contact us for repair.
PV value blinks.	EEPROM error	Normal action	Normal action	Normal action	Normal action	Normal action	Faulty Contact us for repair.
<i>E300</i> (E300)	A/DC error	105%	Preset value output	Normal action	Normal action	Normal action	
<i>b.oUt</i> (B.OUT)	PV burnout error	Dependent on the BSL parameter Up-scale: 105% Down-scale: -5%	Preset value output	Normal action	Normal action	Normal action	Check wires and sensor.
<i>oVr</i> (OVER) or <i>-oVr</i> (-OVER)	Excessive PV Out of -5 to 105%	-5% or 105%	Normal action	Normal action	Normal action	Normal action	Check process.
<i>E200</i> (E200)	Auto-tuning failure (Time-out)	Normal action	Normal action	Normal action	Normal action	Normal action	Check process. Press any key to erase error indication.
SP decimal point blinks. (on setpoint display unit)	Faulty communication line	Normal action	Normal action	Normal action	Normal action	Stopped	Check the Ethernet communication parameters if the error occurs continuously. When the settings are correct, it is faulty. Contact us for repair. Check the error of RS-485 side by the connected controls.
All indications off	Runaway (due to defective power or noise)	None	0% or less or OFF	OFF	0% or less	Stopped	Faulty if power off/on does not reset start the unit. Contact us for repair.
All indications off	Power off	None	0%	OFF	0%	Stopped	Check for abnormal power.

■ If a Power Failure Occurs during Operation

● Momentary Power Failures shorter than 20 ms

The controller is not affected at all and continues normal operation.

● Power Failures of 20 ms or longer

- The alarm function of the controller continues to work normally. (Alarms with the stand-by feature temporarily return to their stand-by state, however.)
- Setting parameters that have already been configured retain their settings.
- Auto-tuning is cancelled.
- After recovery from a power failure, control action resumes in the same mode as the one before the occurrence of the power failure. The control output begins with the preset output value.

■ Troubleshooting when the Controller Fails to Operate Correctly

If your control tasks are not successful, check the preset parameters and controller wiring before concluding the controller to be defective. The following show some examples of troubleshooting you should refer to in order to avoid the possibility of other problems.

● The Controller does not Show the measured input (PV).

- The UT351-xA controllers have a universal input.
The type of PV input can be set/changed using the parameter "IN". At this point, the controller must be wired correctly according to the selected type of PV input. Check the wiring first if the controller fails to show the correct PV. To do this, refer to "2. Initial Settings."
With the parameters "RH", "RL", "SDP", "SH" and "SL", it is possible to scale the input signal and change its number of decimal places. Also check that these parameters are configured correctly.

● The Controller does not Provide any Control Output or the Control Output does not Change at all.

- The UT351-xA controllers have a universal output.
The type of control output can be set/changed using the parameter "OT".
At this point, the controller must be wired correctly according to the selected type of control output. Check the wiring first if the controller provides no control output. To do this, refer to "1.5 Terminal Wiring Diagrams."
With the parameters "OH" and "OL", it is possible to set/change the high and low limits of control output. The control output may not change at all, however, because of restrictions on these parameters. Also check the restrictions on these parameters.
- The control output can only be changed when the controller is in the MAN mode.
If the MAN lamp is off (i.e., the controller is in the AUTO mode), you cannot change the control output using key operation.

● The control output does not change soon after the target setpoint (SP) has been changed.

- If this happens, check the setpoint of the parameter "C.MD". In cases where fixed-point control is selected as the PID control mode (C.MD = 1), tracking based on the I-term works to prevent the control output from changing suddenly even if the target setpoint SP is varied.
The control output therefore may appear to be working incorrectly at first; however it gradually adapts itself to the new target setpoint.

4.2 Maintenance

This section describes the cleaning and maintenance of the UT351.

4.2.1 Cleaning

The front panel and operation keys should be gently wiped with a dry cloth.



NOTE

Do not use alcohol, benzine, or any other solvents.

4.2.2 Replacing Brackets

When the brackets are broken or lost, purchase the following brackets for replacement.

Target Model	Part No.	Sales Unit
UT351	T9115NL	A large bracket and small bracket in pair

SEE ALSO

"1.2 How to Install," for how to replace brackets.

4.2.3 Replacing Parts with a Limited Service Life

The following UT351 parts have a limited service life. The service life given in the table assume that the controller is used under normal operating conditions.

Part	Service life
Aluminum electrolytic condenser	About 10 years (rated)
EEPROM	About 100,000 times of writings
Alarm output relays	About 100,000 more ON-OFF operations or with resistance load
Control output relays	About 100,000 more ON-OFF operations or with resistance load

If any of these parts, except control output relays, cause a controller failure due to deterioration, contact your dealer for replacement at your cost.

SEE ALSO

"4.2.4 Replacing Control Output Relays," for how to replace the control output relays.

4.2.4 Replacing Control Output Relays

This subsection describes how to replace the control output relays.

Since inspection is needed in case of parts replacement, the replacement work should be carried out by a YOKOGAWA engineer or an engineer certified by YOKOGAWA. When replacement is required, contact your nearest YOKOGAWA dealer.



Always turn off the power before starting the work in order to avoid electric shock.

Do not pull out the internal unit for any other purpose other than to replace the control output relays.

1. Insert a flat-blade screwdriver (tip width of 6 mm is recommended) into the opening with the tip in parallel with the front panel, and then turn the screwdriver gently. Take this procedure to four openings 1, 2, 3 and 4 (see the figure below) on the upper and lower parts of the bezel, in order. The bezel slightly moves forward from the housing.

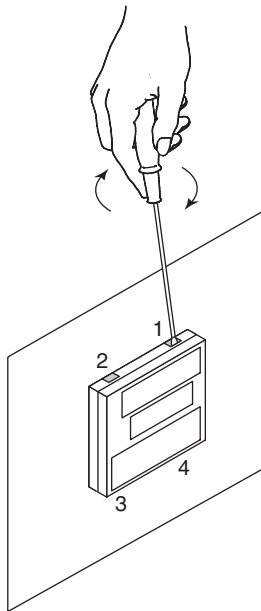

2. Push up the center of the bottom gasket of bezel by a finger to release the latch.

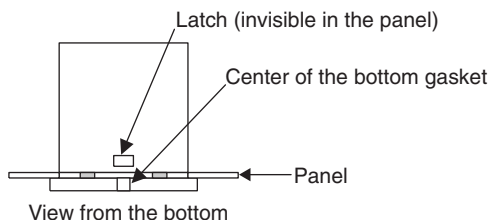

3. Insert the screwdriver into the four openings and flip the tip forward to move the bezel more forward.

4. Hold the bezel and pull it along with the internal unit out of the housing.
(Note) Be careful not to damage the RJC sensor.

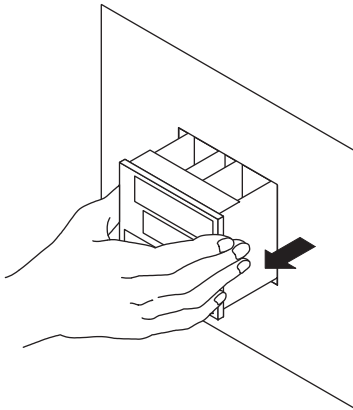

5. The location and number of the relays differ depending on the model code of the UT351. Confirm the location of the control output relay to be replaced before pulling out the relay.

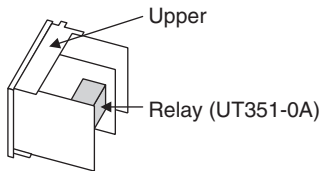

6. Pull out the relay to be replaced.
The control output relays are easy to remove and mount, since they are connected via a socket onto the print boards.

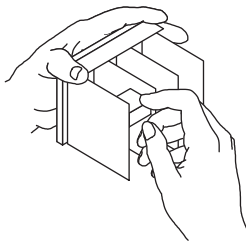

Insert the new relay in the socket. Use the following relay.

Manufacturer	OMRON
Model	G6B-2114P-FD-US-P6B
Power supply	12 V DC

- 7. Insert the internal unit into the housing.**
Apply power to the controller and confirm that the initial operating display is shown. If the operating display is not shown properly, turn off the controller and pull out the internal unit. Then, insert it into the housing again.

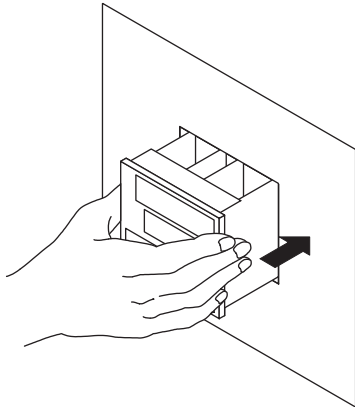

This completes replacement of the control output relay.

Blank Page

5. Parameters

This chapter contains a parameter map as a guideline for setting parameters, and lists of parameters for recording User Settings.



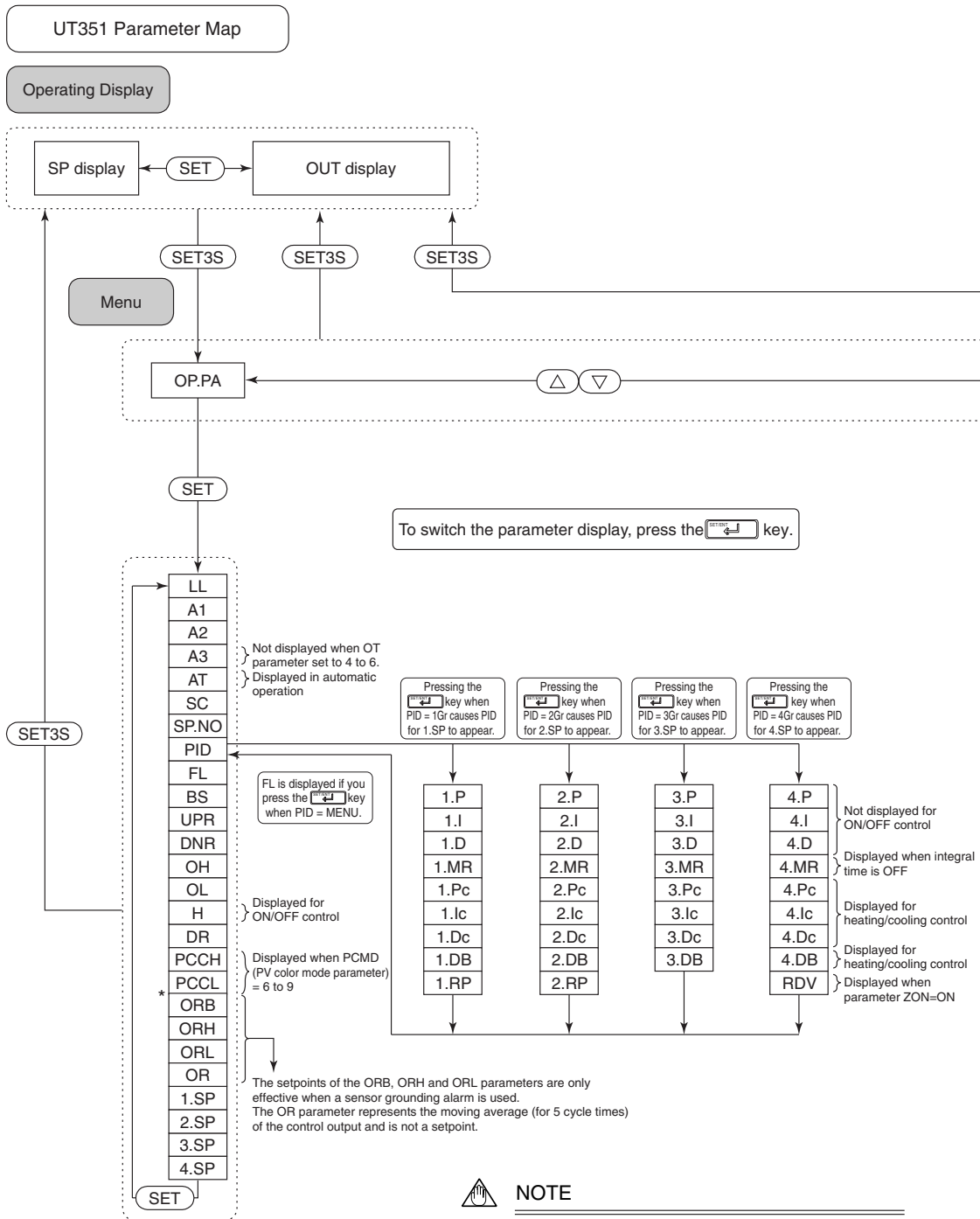

5.1 Parameter Map



* The parameters HB1, HB2, HC1 and HC2 are displayed between DR and ORB or PCCL and ORB. But these parameters do not affect the functions and operations even if they are set up.

NOTE

Changing the registered value of a setup parameter may cause the registered value of an operating parameter to be initialized automatically. Thus, when you have changed a setup parameter, always check that the registered value of the operating parameter is appropriate. If it is initialized to default, reset it to the required value.

SET : Press the  key once.
SET3S : Press the  key for 3 seconds.
Δ ▽ : Press the  or  key once.

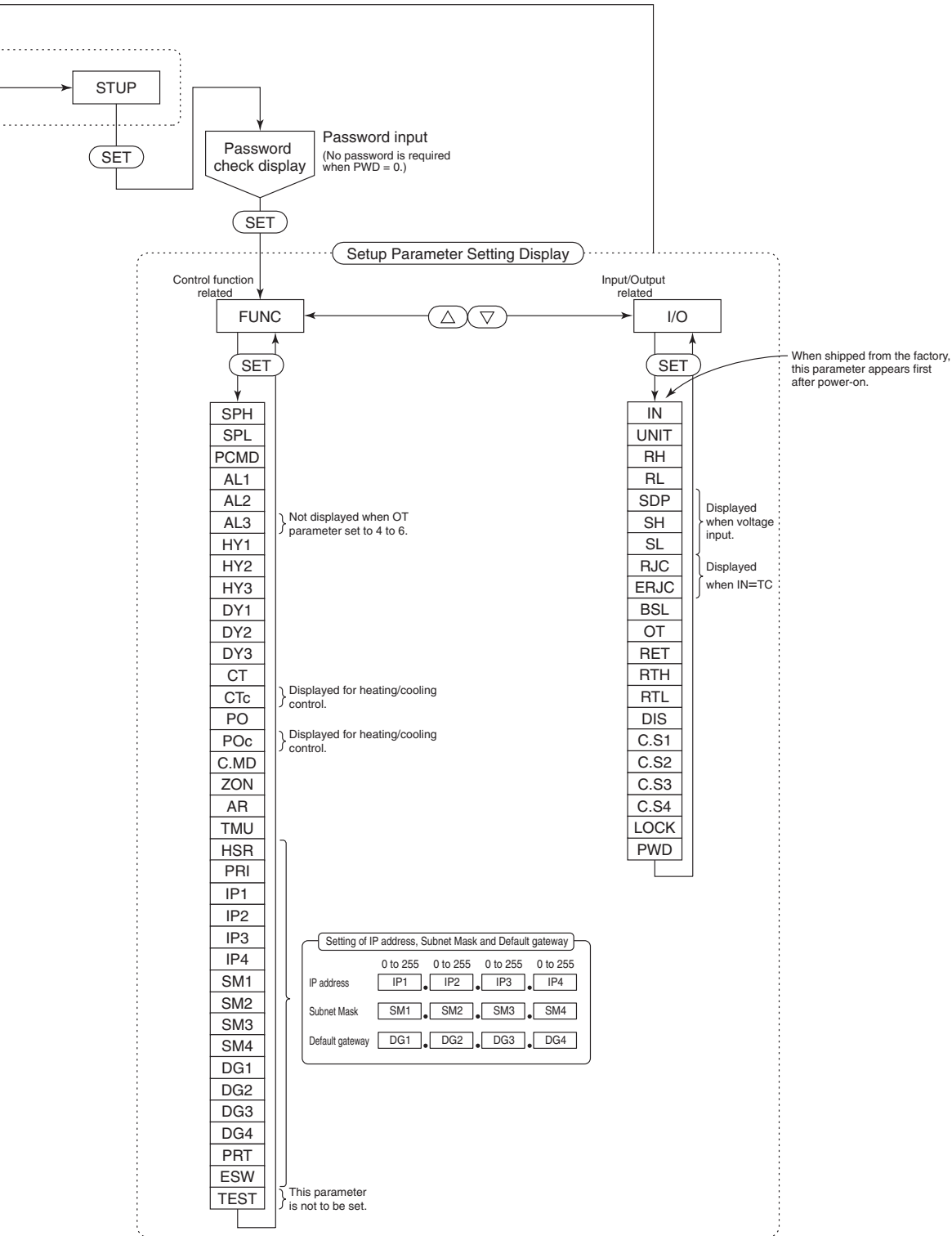

5.2 Lists of Parameters

- * Parameters relating to PV or setpoints should all be set in real numbers. For example, use temperature values to define target setpoints and alarm setpoints for temperature input.
- * The “User Setting” column in the table is provided for the customer to record setpoints.
- * The column “Target Item in CD-ROM” in the table provides references from User’s Manual (Reference) (CD-ROM version) which describes items in more detail and items that are not contained in this manual.
- * Numbers in () are the parameter setpoints that apply when the communication function is used. ex. OFF (0), ON (1)

■ Operating Parameters

Parameter Symbol	Name of Parameter	Setting Range and Description	Initial Value	User Setting	Target Item in CD-ROM
LL (LL)	LL communication interface selection	OFF (0): Communication is carried out via the Ethernet communication terminals. ON (1): Communication is carried out via the light-loader adapter.	with communication : OFF (0) without communication : ON (1)		—
A1 (A1)	Alarm 1-setpoint	PV alarm / SP alarm: -100.0 to 100.0% of PV input range Deviation alarm: -100.0 to 100.0% of PV input range span Output alarm: -5.0 to 105.0% An alarm common to the 1.SP to 4.SP parameters.	PV high limit/SP high limit alarm: 100.0% of PV input range Deviation alarm: 0.0% of PV input range span Other PV/SP low limit alarm: 0.0% of PV input range Output high limit alarm: 100.0% Output low limit alarm: 0.0%		—
A2 (A2)	Alarm 2-setpoint				—
A3 (A3)	Alarm 3-setpoint				—
At (AT)	Auto-tuning	OFF (0): No auto-tuning 1: Auto-tuning for 1.SP 2: Auto-tuning for 2.SP 3: Auto-tuning for 3.SP 4: Auto-tuning for 4.SP AUTO (5): Performs auto-tuning to all groups 1 to 4.	OFF (0)		—
SC (SC)	“Super” function	OFF (0): Disable 1: Overshoot suppressing function Suppresses overshoots generated by abrupt changes in the target setpoint or by disturbances. 2: Hunting suppressing function (Stable mode) Suitable to stabilize the state of control when the load varies greatly, or the target setpoint is changed. Enables to answer the wider characteristic changes compared with Response mode. 3: Hunting suppressing function (Response mode) Enables quick follow-up and short converging time of PV for the changed target setpoint. Note: Use “SUPER” function (SC) 2 or 3 in PID control or PI control. “SUPER” function 2 or 3 is not available in the following controls: 1) ON/OFF control 2) P control (control for proportional band only) 3) PD control (control for proportional band and derivative item only) 4) Heating/cooling control Do not use hunting suppressing function when control processes with response such as flow or pressure control.	OFF (0)		Ref.2.1(5) Ref.2.1(6)
SP.no (SP.NO)	Target setpoint number selection	0: Use target setpoint via communication. 1: Selects target setpoint 1 (1.SP). 2: Selects target setpoint 2 (2.SP). 3: Selects target setpoint 3 (3.SP). 4: Selects target setpoint 4 (4.SP).	1		Ref.4.1(1)
PI d (PID)	PID parameter display number	MENU (0): Move to FL parameter display 1Gr (1) to 4Gr (4): Display of each PID parameter	MENU (0)		

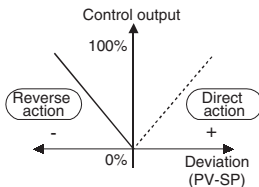
Parameter Symbol	Name of Parameter	Setting Range and Description	Initial Value	User Setting	Target Item in CD-ROM
FL (FL)	PV input filter	OFF (0), 1 to 120 second. Used when the PV input fluctuates.	OFF (0)		Ref.1.1(1)
bs (BS)	PV input bias	-100.0% to 100.0% of PV input range span Used to correct the PV input range.	0.0% of PV input range span		
UPr (UPR)	Setpoint ramp-up-rate	OFF (0) 0.0% + 1 digit of PV input range span to 100.0% of PV input range span Set ramp-up-rate or ramp-down-rate per hour or minute. Sets unit in ramp-rate-time unit (TMU).	OFF (0)		Ref.4.1(4)
dnr (DNR)	Setpoint ramp-down-rate		OFF (0)		
oH (OH)	Output high limit Heating-side output high limit (in heating/cooling control)	-5.0 to 105.0% Heating-side limiter in heating/cooling control: 0.0 to 105.0% (OL < OH)	100% Heating/cooling control: 100.0%		Ref.2.1(3)
oL (OL)	Output low limit Cooling-side output high limit (in heating/cooling control)	-5.0 to 105.0% Cooling-side limiter in heating/cooling control: 0.0 to 105.0% (OL < OH)	0.0% Heating/cooling control: 100.0%		
H (H)	ON/OFF control hysteresis Heating-side/cooling-side ON/OFF control hysteresis (in heating/cooling control)	In ON/OFF control: 0.0 to 100.0% of PV input range span In heating/cooling control: 0.0 to 100.0%	ON/OFF control: 0.5% of PV input range span Heating/cooling control: 0.5%		—
dr (DR)	Direct/reverse action switching	0: reverse action, 1: direct action 	0		Ref.2.1(1)
PCCH (PCCH)	High limit for PV color change	When PCMD (PV color mode parameter) = 6 or 7 : -100.0 to 100.0 % of PV input range When PCMD (PV color mode parameter) = 8 or 9 : -100.0 to 100.0 % of PV input range span	When PCMD = 6 or 7 : PCCH = 100.0%, PCCL = 0.0 % When PCMD = 8 or 9 : PCCH and PCCL = 1.0 %		—
PCCL (PCCL)	Low limit for PV color change				
orb (ORB)	ON/OFF rate detection band	0.0 to 100.0% of PV input range span	1.0% of PV input range span		Ref.3.3(4)
orH (ORH)	ON/OFF rate high limit	ORL + 1 digit to 105.0%	100.0%		
orL (ORL)	ON/OFF rate low limit	-5.0% to ORH - 1 digit	0.0%		
or (OR)	ON/OFF rate	This is not a setpoint.	The moving average (for 5 cycle times) of the control output is shown.		
1SP (1.SP)	Target setpoint-1	0.0 to 100.0% of PV input range However, between target setpoint limiter lower limit (SPL) and upper limit (SPH).	0.0% of PV input range		Ref.4.1(1)
2SP (2.SP)	Target setpoint-2				
3SP (3.SP)	Target setpoint-3				
4SP (4.SP)	Target setpoint-4				

Note: The parameters HB1, HB2, HC1 and HC2 are displayed between DR and ORB or PCCL and ORB.
But these parameters do not affect the functions and operations even if they are set up.

● **PID-related Parameters**

The following parameters are displayed when “1Gr” is set to PID parameter display number (PID).

In this case, the corresponding target setpoint is 1.SP (target setpoint-1).

To set PID corresponding to target setpoint 2 to 4, set “2Gr”, “3Gr”, or “4Gr” to PID. The relevant parameters will then be displayed.

Parameter Symbol	Name of Parameter	Setting Range and Description	Initial Value	User Setting	Target Item in CD-ROM
1P (1.P)	Proportional band/Heating-side proportional band (in heating/cooling control)	0.1 to 999.9% In heating/cooling control: 0.0 to 999.9% (heating-side ON/OFF control applies when 0.0)	5.0%		Ref.4.1(1)
1I (1.I)	Integral time Heating-side integral time (in heating/cooling control)	OFF (0), 1 to 6000 second.	240 second.		
1d (1.D)	Derivative time Heating-side derivative time (in heating/cooling control)	OFF (0), 1 to 6000 second.	60 second.		
1mr (1.MR)	Manual reset	-5.0 to 105.0% (enabled when integral time “1.I” is OFF) The manual reset value equals the output value when PV = SP is true. For example, if the manual reset value is 50%, the output value is 50% when PV = SP becomes true.	50.0%		
1Pc (1.Pc)	Cooling-side proportional band	0.0 to 999.9% (Cooling-side ON/OFF control applies when 0.0)	5.0%		
1Ic (1.Ic)	Cooling-side integral time	OFF (0), 1 to 6000 second.	240 second.		
1dc (1.Dc)	Cooling-side derivative time	OFF (0), 1 to 6000 second.	60 second.		
1db (1.DB)	Deadband	-100.0 to 50.0% In heating/cooling control, a region where both of the heating- and cooling-side outputs are presented, or non of them is presented, can be set.	3.0%		
1rP (1.RP)	Zone PID reference point-1	0.0 to 100.0% of PV input range. Note that 1.RP ≤ 2.RP.	100% value of PV input range		

Refer to the table below for recording setpoints when two sets or more of PID parameters are used.

Parameter	n=2	n=3	n=4
n.P			
n.I			
n.D			
n.MR			
n.Pc			
n.Ic			
n.Dc			
n.DB			
n.RP		None	None

rdb (RDV)	Reference deviation	OFF (0), 0.0 to 100.0% of PV input range span Used to select PID constants according to a deviation from the setpoint. The 4th group of PID constants is used when the controller fails to keep track of the deviation.	OFF (0)		Ref.4.1(1)
---------------------	---------------------	--	---------	--	------------

■ Auto-tuning

Auto-tuning is a function with which the controller automatically measures the process characteristics to automatically set the optimum PID constants. This function does not work when the controller is performing on-off control. The UT351-xA employ the “Limit Cycle Method.” As shown in the figure below, the controller temporarily changes its control output in a step-waveform manner. Then, it calculates the optimum proportional band (P), integral time (I) and derivative time (D) from the resulting response to set them in their respective parameters.

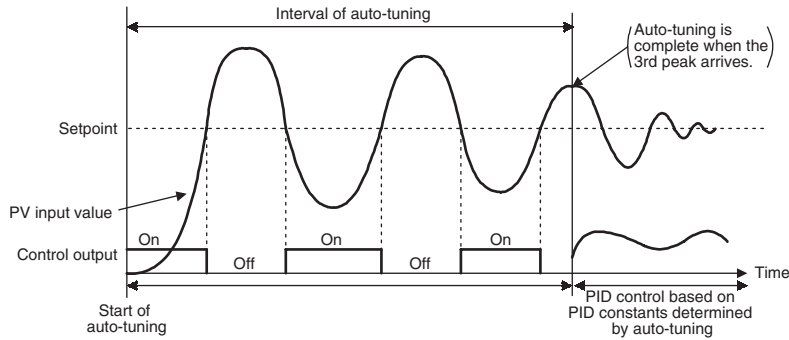

If the Output High Limit (OH) and Output Low Limit (OL) parameters are already configured, the control output turns on and off only between the output's high and low limits during auto-tuning.

● Auto-tuning Using Zone PID (see “■ PID Switching (Zone PID)” later in this chapter)

Setting of AT Parameter	Auto-tuned Setpoint	Remarks
OFF	-	Auto-tuning is turned off (disabled).
1	The setpoints when auto-tuning is started	Determines the values of 1.P, 1.I and 1.D parameters by auto-tuning.
2		Determines the values of 2.P, 2.I and 2.D parameters by auto-tuning.
3		Determines the values of 3.P, 3.I and 3.D parameters by auto-tuning.
4		Determines the values of 4.P, 4.I and 4.D parameters by auto-tuning.
AUTO	Median value of each zone width	Determines the values of all PID parameters in use by auto-tuning.

The AT parameter settings numbered 1 to 4 in the table above are dependent on how many zones have been set. For example, if you have set two zones, you can use AT parameter settings 1 and 2. Likewise, if you have set three zones, you can use AT parameter settings 1, 2 and 3.

■ Hysteresis (for Target Setpoints (On-Off Control) and Alarm Setpoints)

Hysteresis can be set in on-off control setpoints and alarm setpoints as well. With the hysteresis settings, it is possible to prevent relays from chattering.

- When hysteresis is set in a target setpoint

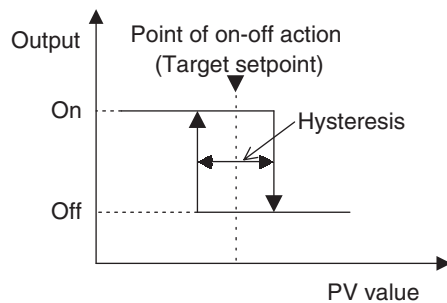

- When hysteresis is set in an alarm setpoint

Example of hysteresis set in PV high limit alarm

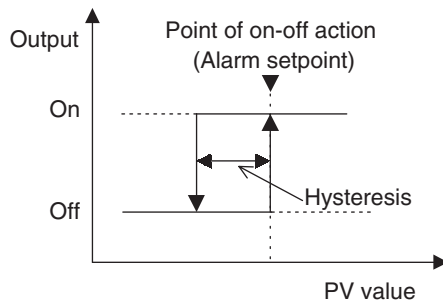

■ Target Setpoint Ramp Setting Function

Use this function to prevent the target setpoint from changing suddenly. The ramp setting function works when:

- [1] the target setpoint is changed (example: change in “1.SP” from 100°C to 150°C);
- [2] the target setpoint number is switched (example: switch from “1.SP” to “3.SP”);
- [3] the power is turned on or the controller is recovered from power failure;
- [4] a change is made from manual operation to automatic operation; or
- [5] a change is made from the STOP state to the RUN state.

If the target setpoint before switching is smaller than the target setpoint after switching, the controller operates according to the settings of the Setpoint Ramp UP (UPR) and Ramp Time Unit (TMU) parameters. If the target setpoint before switching is greater than the target setpoint after switching, the controller operates according to the settings of the Setpoint Ramp Down (DNR) and Ramp Time Unit (TMU) parameters.



NOTE

When using target setpoint ramp setting function, PV tracking works in case of the above conditions [2] to [5].

The figure below shows an example when the Target Setpoint Number (SP.NO) parameter is switched. The 1.SP and 2.SP parameters are set to 500°C and 640°C, respectively. Thus, there is a temperature difference of 140°C between the 1.SP and 2.SP parameters. This example shows how the temperature is changed by as much as this temperature difference over a period of two minutes. In this example, the UPR parameter is 70°C and the TMU parameter is 1 minute.

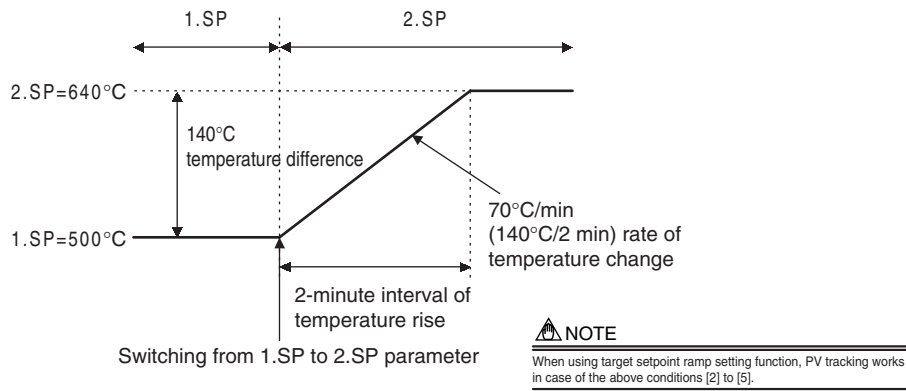

■ PID Switching (Zone PID)

Using a zone PID, you can automatically switch between groups of PID constants according to the temperature zone. You can set a maximum of three temperature zones.

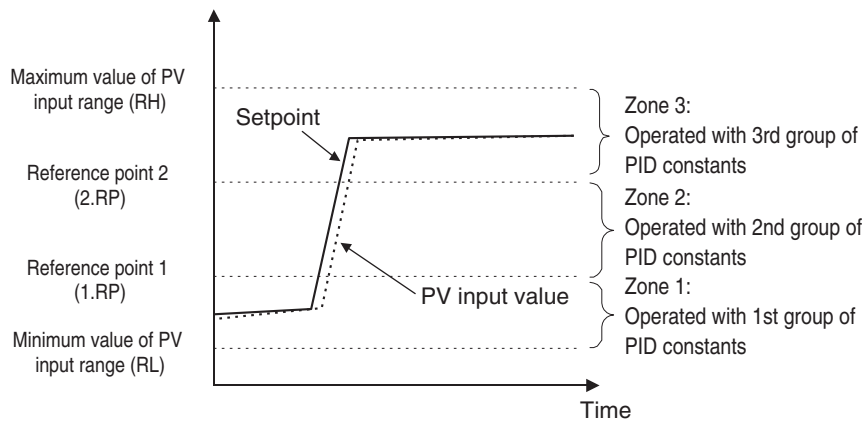

<Setting Method>

- [1] Set the Zone PID Selection (ZON) parameter to "ON".
- [2] Define a reference point.
 When using two zones, define only reference point 1 (1.RP) between the minimum and maximum values of the PV input range.
 When using three zones, define reference points 1 and 2 (1.RP and 2.RP) in the same way as noted above.

NOTE

Set the maximum and minimum values, as close as possible to those of the actual range to be controlled, in the Maximum Value of PV Input Range (RH) and Minimum Value of PV Input Range (RL) parameters. Otherwise, the controller may fail to determine the optimum values when auto-tuning is carried out.

■ Setup Parameters

● Control Function-related Parameters

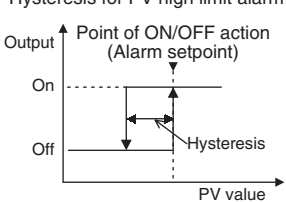
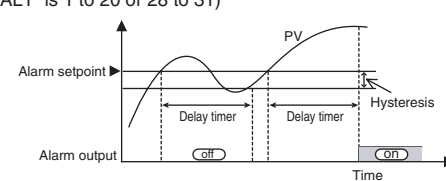
Parameter Symbol	Name of Parameter	Setting Range and Description	Initial Value	User Setting	Target Item in CD-ROM
SPH (SPH)	Target setpoint limiter upper limit	0.0 to 100.0% of PV input range where, SPL < SPH Places a limit on the range within which the target setpoint is changed.	100.0% of PV input range		—
SPL (SPL)	Target setpoint limiter lower limit		0.0% of PV input range		—
PCmd (PCMD)	PV color mode	0: Fixed in green 1: Fixed in red 2: Link to alarm 1 (Alarm OFF:green, Alarm ON:red) 3: Link to alarm 1 (Alarm OFF:red, Alarm ON:green) 4: Link to alarm 1 and 2 (Alarm OFF:green, Alarm ON:red) 5: Link to alarm 1 and 2 (Alarm ON:red, Alarm OFF:green) 6: PV limit (Within PV range:green, Out of PV range:red) 7: PV limit (Within PV range:red, Out of PV range:green) 8: SP deviation (Within deviation:green, Out of deviation:red) 9: SP deviation (Within deviation:red, Out of deviation:green)	1		—
AL1 (AL1)	Alarm-1 type	OFF (0), 1 to 23, 28 to 31, 33 to 38, 43 to 48 1: PV high limit (energized, no stand-by action) 2: PV low limit (energized, no stand-by action) 3: Deviation high limit (energized, no stand-by action) 4: Deviation low limit (energized, no stand-by action) 5: Deviation high limit (de-energized, no stand-by action) 6: Deviation low limit (de-energized, no stand-by action) These Alarm Type parameters are common to the parameters 1.SP to 4.SP. See "2.5 Changing Alarm Type" for other alarm types.	1		Ref.3.3(4)
AL2 (AL2)	Alarm-2 type		2		
AL3 (AL3)	Alarm-3 type		1		
HY1 (HY1)	Alarm-1 hysteresis	0.0 to 100.0% of PV input range span Output alarm: 0.0 to 100.0% Hysteresis for PV high limit alarm 	0.5% of PV input range span Output alarm: 0.5%		Ref.3.3(2)
HY2 (HY2)	Alarm-2 hysteresis				
HY3 (HY3)	Alarm-3 hysteresis				
DY1 (DY1)	Alarm-1 delay timer	An alarm is output when the delay timer expires after the alarm setpoint is reached. 0.00 to 99.59 (min, sec.) (enabled when alarm-1 type "AL1" is 1 to 20 or 28 to 31) 	0.00		—
DY2 (DY2)	Alarm-2 delay timer	0.00 to 99.59 (min, sec.) (enabled when alarm-2 type "AL2" is 1 to 20 or 28 to 31)			
DY3 (DY3)	Alarm-3 delay timer	0.00 to 99.59 (min, sec.) (enabled when alarm-3 type "AL3" is 1 to 20 or 28 to 31)			
CT (CT)	Control output cycle time Heating-side control output cycle time (in heating/cooling control)	1 to 1000 second.	30 second.		Ref.3.3(4)
CTc (CTc)	Cooling-side control output cycle time	1 to 1000 second.	30 second.		—
PO (PO)	Preset output/Heating-side preset output (in heating/cooling control)	-5.0 to 105.0% In heating/cooling control: Heating side 0.0 to 105.0% In Stop mode, fixed control output can be generated.	0.0%		Ref.2.1(8)
POc (POc)	Cooling-side preset output	0.0 to 105.0% In Stop mode, cooling-side fixed control output can be generated.	0.0%		

Parameter Symbol	Name of Parameter	Setting Range and Description	Initial Value	User Setting	Target Item in CD-ROM
Cnd (C.MD)	PID control mode	0: Standard PID control (with output bump at SP change) 1: Fixed Point control (without output bump at SP change) Choose "Fixed Point Control" when controlling pressure or flow rate.	0		Ref.2.1(2)
Zon (ZON)	Zone PID selection	OFF: SP selection ON: Zone PID	OFF		Ref.4.1(2)
Ar (AR)	Anti-reset windup (Excess integration prevention)	AUTO (0), 50.0 to 200.0% Used when the control output travels up to 100% or down to 0% and stays at this point. The larger SP, the sooner PID computation (integral computation) stops.	AUTO (0)		Ref.2.1(4)
tNU (TMU)	Ramp-rate time unit setting	0: hour, 1: minute Time unit of setpoint ramp-up (UPR) and setpoint ramp-down (DNR)	0		Ref.4.1(4)
HSr (HSR)	High-speed response mode	OFF: The process data high-speed response function is not used. 1: The process data of the device itself is returned as a response at high speed. 2 to 8: The process data of the device itself and the process data from the serial communication devices connected to the RS485 communication terminals are returned as a response at high speed. The maximum address of the serial devices is specified. Note: Set the continuous communication address which begins from "2" for other serial communication devices connected to the RS485 communication terminals. Note: After setting the parameter HSR, set the Ethernet setting switch ESW to "1" to activate the settings. If other parameters (IP address, subnet mask or default gateway) are also changed, activate the settings at the end.	1		
Pri (PRI)	Parity	Set the parity of RS485 communication to be connected to the Ethernet-serial gateway function. 0: None 1: Even 2: Odd Note: Set the same parity as that of the other devices to be connected. Note: After setting the parameters PRI, set "1" for the parameter ESW to make the setting effective.	1		
IP1 (IP1)	IP address 1	Set the IP address by the following format. 0 to 255 0 to 255 0 to 255 0 to 255 IP address <input type="text" value="IP1"/> . <input type="text" value="IP2"/> . <input type="text" value="IP3"/> . <input type="text" value="IP4"/> Note: After setting the parameters IP, set "1" for the parameter ESW to make the setting effective.	192		
IP2 (IP2)	IP address 2		168		
IP3 (IP3)	IP address 3		1		
IP4 (IP4)	IP address 4		1		
Sn1 (SM1)	Subnet mask 1	Set the Subnet Mask by the following format. 0 to 255 0 to 255 0 to 255 0 to 255 Subnet Mask <input type="text" value="SM1"/> . <input type="text" value="SM2"/> . <input type="text" value="SM3"/> . <input type="text" value="SM4"/> Note: After setting the parameters SM, set "1" for the parameter ESW to make the setting effective.	255		Communication function
Sn2 (SM2)	Subnet mask 2		255		
Sn3 (SM3)	Subnet mask 3		255		
Sn4 (SM4)	Subnet mask 4		0		
DG1 (DG1)	Default gateway 1	Set the Default gateway by the following format. 0 to 255 0 to 255 0 to 255 0 to 255 Default gateway <input type="text" value="DG1"/> . <input type="text" value="DG2"/> . <input type="text" value="DG3"/> . <input type="text" value="DG4"/> Note: After setting the parameters DG, set "1" for the parameter ESW to make the setting effective.	0		
DG2 (DG2)	Default gateway 2		0		
DG3 (DG3)	Default gateway 3		0		
DG4 (DG4)	Default gateway 4		0		
Prt (PRT)	Port Number	Set the HEX data format. Setting range: 01F6f (502), 0400h (1024) to FFFFh (65535) Note: After setting the parameters PRT, set "1" for the parameter ESW to make the setting effective.	01F6h (502)		
ESW (ESW)	Ethernet setting switch	Be sure to set "1" for the parameter ESW after setting the parameters HSR through DG4. The settings of the parameters HSR through DG4 become effective by setting "1" for the parameter ESW. (The settings also become effective by power OFF/ON.) Note: The parameter ESW automatically returns to "0" after "1" is set.	0		
tEST (TEST)	If this parameter symbol appears, press the SET/ENT key to return to the FUNC menu. Caution: Do not change the setpoint of the TEST parameter, otherwise the controller will be disabled.				

● Input-/Output-related Parameters

Parameter Symbol	Name of Parameter	Setting Range and Description	Initial Value	User Setting	Target Item in CD-ROM
In (IN)	PV input type (PV INPUT terminals) ① - ⑫ - ⑬ terminals	OFF (0), 1 to 18, 30, 31, 35 to 37, 40, 41, 50, 51, 55, 56 See "Instrument Input Range Codes" in "2. Initial Settings."	OFF (0)		—
Unit (UNIT)	PV input unit	°C (0): Degree Celsius °F (1): Fahrenheit (This parameter is not shown for voltage input.)	°C (0)		—
rH (RH)	Max. value of PV input range	Set the PV input range, however RL < RH - Temperature input Set the range of temperature that is actually controlled.	Max. value of instrument input range		—
rL (RL)	Min. value of PV input range	- Voltage input Set the range of a voltage signal that is applied. The scale across which the voltage signal is actually controlled should be set using the parameters Maximum Value of PV Input Scale (SH) and Minimum Value of PV Input Scale (SL).	Min. value of instrument input range		—
SDP (SDP)	PV input decimal point position (displayed at voltage input)	0 to 3 Set the position of the decimal point of voltage-mode PV input. 0: No decimal place 1: One decimal place 2,3: Two, three decimal places	1		—
SH (SH)	Max. value of PV input scale (displayed at voltage input)	-1999 to 9999, however SL < SH Set the read-out scale of voltage-mode PV input.	100.0		—
SL (SL)	Min. value of PV input scale (displayed at voltage input)		0.0		—
rJc (RJC)	Presence/absence of PV input reference junction compensation	OFF (0), ON (1)	ON (1)		—
ErJc (ERJC)	External RJC setpoint	-50.0 to 50.0 °C -58.0 to 122.0 °F For thermocouple input, temperature compensation value outside the controller can be set. Available only when RJC =OFF.	0.0 °C 32.0 °F		—
BSL (BSL)	Selection of PV input burnout action	OFF (0) 1: Up scale 2: Down scale	1		—
ot (OT)	Control output type	0 Time proportional PID relay contact output (terminals ①-②-③) 1 Time proportional PID voltage pulse output (terminals ⑬-⑭) 2 Current output (terminals ⑬ - ⑭) 3 ON/OFF control relay contact output (terminals ① - ② - ③) The following 4 to 12 are displayed only for heating/ cooling type controllers.	0		—
	Alarm-3 cannot be used when OT=4 to 6.	4 Heating-side relay output (terminals ① - ② - ③), cooling-side relay output (terminals ④ - ⑦) 5 Heating-side pulse output (terminals ⑬ - ⑭), cooling-side relay output (terminals ④ - ⑦) 6 Heating-side current output (terminals ⑬ - ⑭), cooling-side relay output (terminals ④ - ⑦) 7 Heating-side relay output (terminals ① - ② - ③), cooling-side pulse output (terminals ⑭ - ⑮) 8 Heating-side pulse output (terminals ⑬ - ⑭), cooling-side pulse output (terminals ⑭ - ⑮) 9 Heating-side current output (terminals ⑬ - ⑭), cooling-side pulse output (terminals ⑭ - ⑮) 10 Heating-side relay output (terminals ① - ② - ③), cooling-side current output (terminals ⑭ - ⑮) 11 Heating-side pulse output (terminals ⑬ - ⑭), cooling-side current output (terminals ⑭ - ⑮) 12 Heating-side current output (terminals ⑬ - ⑭), cooling-side current output (terminals ⑭ - ⑮)	Heating/cooling type: 4		—

Parameter Symbol	Name of Parameter	Setting Range and Description	Initial Value	User Setting	Target Item in CD-ROM
RET (RET)	Retransmission output type	1: PV, 2: SP, 3: OUT, 4: Loop power supply for sensor (15 V) In heating/cooling control, an output value before allocation to heating and cooling control (0 to 100%) is transmitted if setpoint "3" is selected (0 to 50%: Cooling-side output; 50 to 100%: Heating-side output).	1		Ref.2.2(1)
RTH (RTH)	Max. value of retransmission output scale	RET=1, 2: RTL + 1 digit to 100.0% of PV input range	100.0% of PV input range		
RTL (RTL)	Min. value of retransmission output scale	RET=1, 2: 0.0% of PV input range to RTH - 1 digit	0.0% of PV input range		
DIS (DIS)	DI function selection	OFF (0) Disables the external contact input.	1		Ref.3.1(1)
		1 DI1: 2.SP (on)/1.SP (off), DI2: AUTO (on)/MAN (off)			
		2 DI1: Hides (on)/shows (off) the LOCK setup parameter. DI2: Unused.			
		3 See the table below.			
		4 DI1: 2.SP (on)/1.SP (off), DI2: STOP (on)/RUN (off)			

• SP Selection when DIS = 3 is set

	DI1	DI2
1.SP	OFF	OFF
2.SP	ON	OFF
3.SP	OFF	ON
4.SP	ON	ON

C.S1 (C.S1)	SELECT display-1 registration	OFF (0), 201 to 1015 Select the desired parameter from among the operating and setup parameters, then register the number (D register No.) accompanying that parameter. For example, registering "231" for C.S1 allows you to change alarm-1 setpoint in operating display. Numbers for registering alarm SP parameter for operating display: Alarm-1 setpoint: 231 Alarm-2 setpoint: 232 Alarm-3 setpoint: 233 Above numbers are alarm setpoint parameters for target setpoint-1 (1.SP).	OFF (0)		Ref.6.1(1)
C.S2 (C.S2)	SELECT display-2 registration				
C.S3 (C.S3)	SELECT display-3 registration				
C.S4 (C.S4)	SELECT display-4 registration				
LOCK (LOCK)	Key lock	OFF (0): No key lock 1: Change to any parameter prohibited Prohibits any operating parameter or setup parameter from being changed. The setpoint of the LOCK parameter itself can be changed, however. 2: Change to and display of operating parameters prohibited Turns off the display for setting operating parameters, thus prohibiting any change to the parameter settings. (Hold down the SET/ENT key for more than 3 seconds to show the password check display.) 3: Disables the A/M key on the instrument's front panel.	OFF (0)		Ref.7.1(2)
PWD (PWD)	Password setting	0: Password not set 1 to 9999	0		Ref.7.1(1)

■ Functions of Active Color PV Display

This part describes the functions of “Active Color PV Display.” PV display color is changed by the following four actions.

PV display is selectable from red-to-green or green-to-red changing action, or fixed color.

Link to alarm 1 mode (when PCMD = 2, 3) (Setting example-1)

Link to alarm 1 and 2 mode (when PCMD = 4, 5) is the same. When either of the alarms occurs, the display color is changed.

SP deviation mode (when PCMD = 8, 9) (Setting example-2)

PV limit mode (when PCMD = 6, 7) (Setting example-3)

Fixed color mode (when PCMD = 0, 1) (Setting example-4)

Setting Example-1 : Link to Alarm

Works linking to alarm 1.

Set “PV high limit alarm” for alarm -1 type, and “80°C” for alarm -1 setpoint.

If PCMD (PV color mode parameter) = 2, PV display color is changed from green to red when PV input value exceeds alarm -1 setpoint.

The red-to-green changing action is selectable.

Setting parameters:

PCMD (PV color mode parameter) = 2

AL1 (Alarm -1 type parameter) = 1

A1 (Alarm -1 setpoint parameter) = 80°C

HY1 (Alarm -1 hysteresis parameter) = 5°C

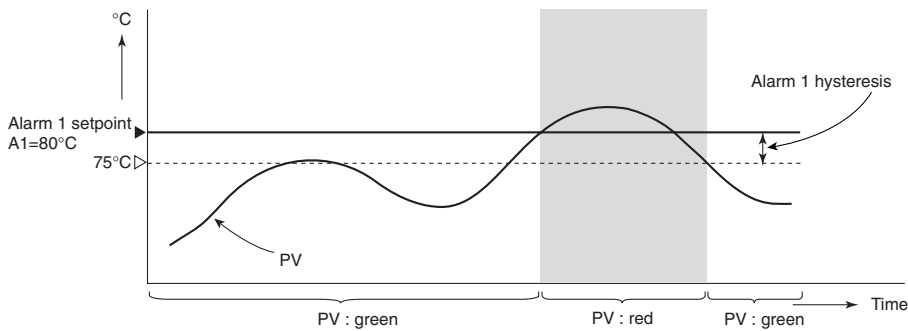

Setting Example-2 : Change by Deviation

Set the high limit deviation band “10°C” for PCCH the and low limit deviation band “5°C” for PCCL, for the current setpoint “50°C.”

PV display color is changed from green to red when PV input value is out of the deviation.

The red-to-green changing action is selectable.

Setting parameters:

PCMD (PV color mode parameter) = 8

PCCH (High limit for PV color change parameter) = 10°C

PCCL (Low limit for PV color change parameter) = 5°C

Hysteresis fixed to 0.25% is inserted where PV display color is changed.

In the example below, where changed from red to green.

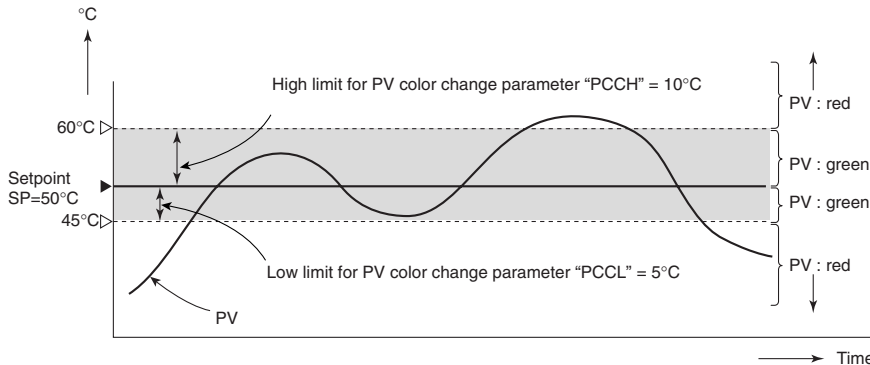

Setting Example-3 : Link to PV

Set the high limit "70°C" for PCCH, and the low limit "20°C" for PCCL.
PV display color is changed from green to red when PV input value is out of the range.
The red-to-green changing action is selectable.
Setting parameters:
PCMD (PV color mode parameter) = 6
PCCH (High limit for PV color change parameter) = 70°C
PCCL (Low limit for PV color change parameter) = 20°C
Hysteresis fixed to 0.25% is inserted where PV display color is changed.
In the example below, where changed from red to green.

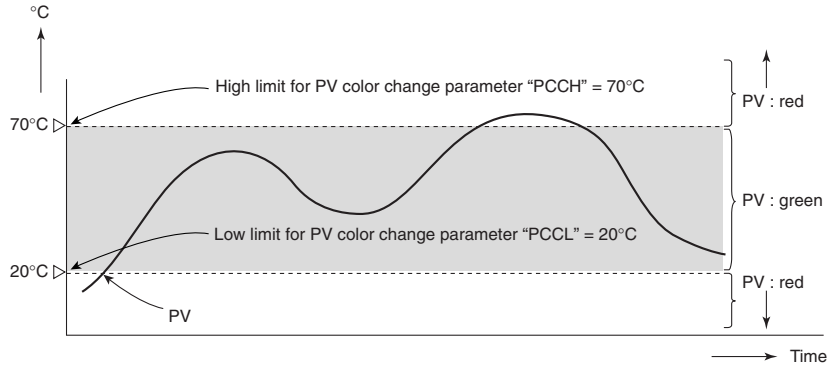

Setting Example-4 : Fixed in Red or Green

Set the PV display color or Fixed in green mode, Setting of Fixed to red mode is also possible.
Setting parameter
PCMD (PV color mode parameter) = 0

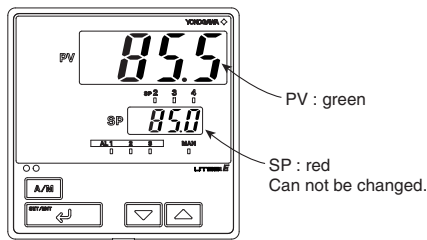

External RJC

The external RJC is not a compensation function built in a controller but a compensation function working outside the controller.

The external RJC is used when the input is thermocouple, and RJC=OFF.

Using external RJC makes the accuracy of RJC higher and shortens the compensating wire..

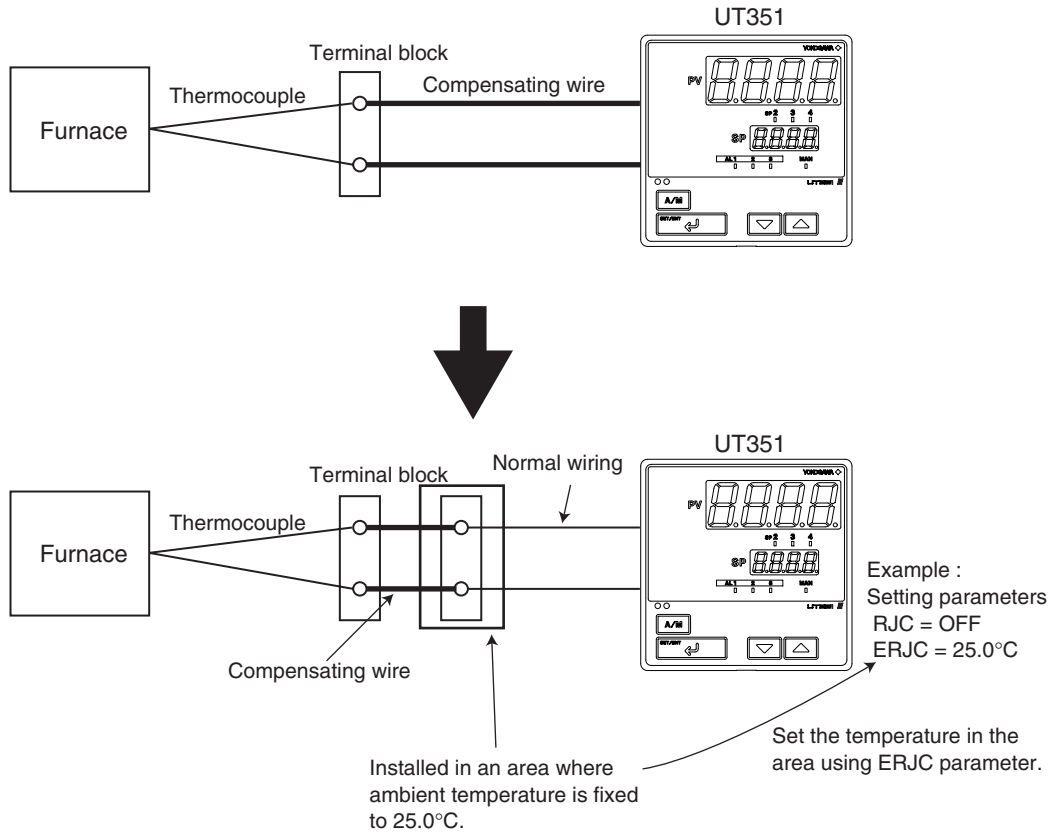

■ Useful Operating Displays (SELECT Display)

Registering frequently changed parameters in the SELECT display after ordinary operating displays will allow you to change settings easily. A maximum of four displays can be registered.

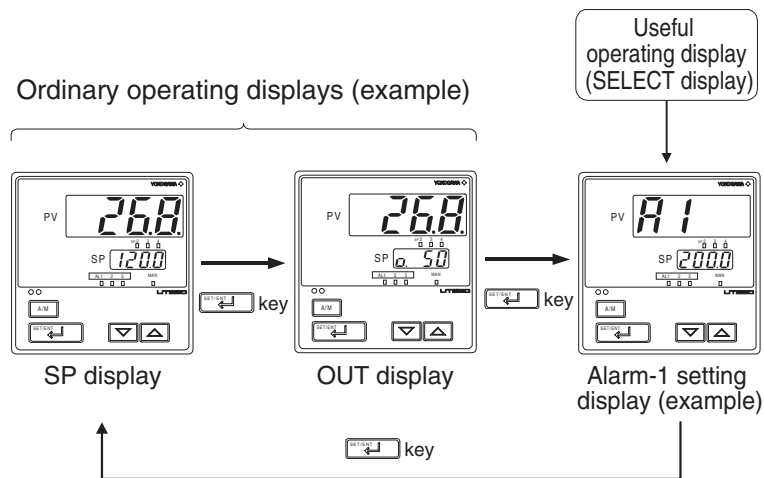

<Setting method>

Set the parameter numbers (D register numbers) you wish to register for setup parameters C.S1 to C.S4.

Alarm parameter for target setpoint-1	Registration number
Alarm-1 setpoint parameter	231
Alarm-2 setpoint parameter	232
Alarm-3 setpoint parameter	233

For any registration number other than those above, see User's Manual (Reference) (CD-ROM version).

■ Heating/Cooling Control (for a Heating/Cooling Controller Only)

In heating/cooling control, the controller outputs the result of computation after splitting it into heating-purpose and cooling-purpose signals. In addition, the controller can perform PID control or on-off control on the heating and cooling sides separately. When performing on-off control, set the proportional band to "0".

The controller splits the result of computation (0 to 100%) into heating-side and cooling-side signals, as described below.

- 0% to 50% of the computation result is presented as a 0% to 100% cooling-side output.
- 50% to 100% of the computation result is presented as a 0% to 100% heating-side output.

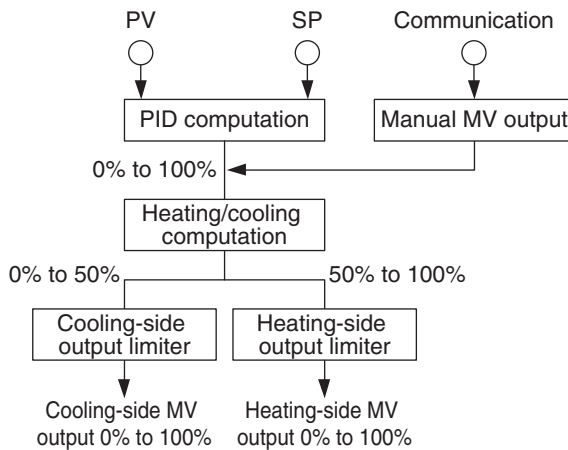

Heating/cooling control provides two methods in which either none of the heating- and cooling-side outputs are presented or both of the heating- and cooling-side outputs are presented, as shown in the following figures.

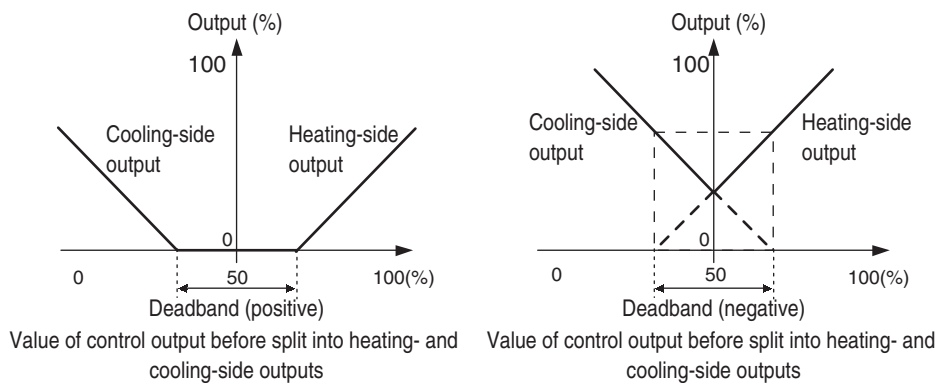

Precautions in Heating/Cooling Control

- Keep the ratio of the heating-side proportional band (P) to the cooling-side proportional band (Pc) equal to or below 5.
- If neither the heating side nor the cooling side is performing on-off control, setting the integral time (I or Ic) of one side to "0" results in the Integral Time parameters of both sides being set to "OFF", irrespective of the integral time setting of the other side.

■ Cycle Time

A cycle time can only be set if the type of control output is time proportional PID relay output or time proportional voltage pulse output.

A cycle time refers to one period consisting of on-and off-state time lengths.

The ratio of the on-state time to the off-state time differs according to the value of the control output.

The figure below shows on-to-off time ratios of the control output when the cycle time is set to 10 seconds. Setting a shorter cycle time allows the controller to perform elaborate control at short time intervals. This significantly reduces the on-and off-state times, however it shortens the service life of a relay.

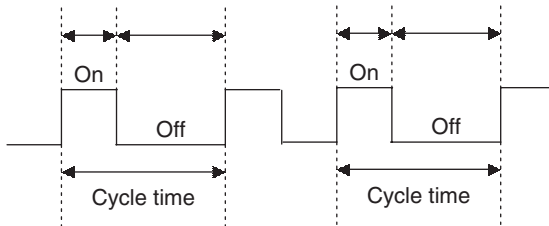

Relay's Behavior when Cycle Time = 10 sec.

For 20% of Control Output	For 50% of Control Output	For 80% of Control Output
 On-state duration: 2 sec. Off-state duration: 8 sec.	 On-state duration: 5 sec. Off-state duration: 5 sec.	 On-state duration: 8 sec. Off-state duration: 2 sec.

Blank Page

6. Function Block Diagram and Descriptions

This chapter contains the function block diagrams for “Standard type,” and “Heating/cooling type.” For details on these function block diagrams, refer to the descriptions mentioned later.

■ Function Block Diagram for Standard Type

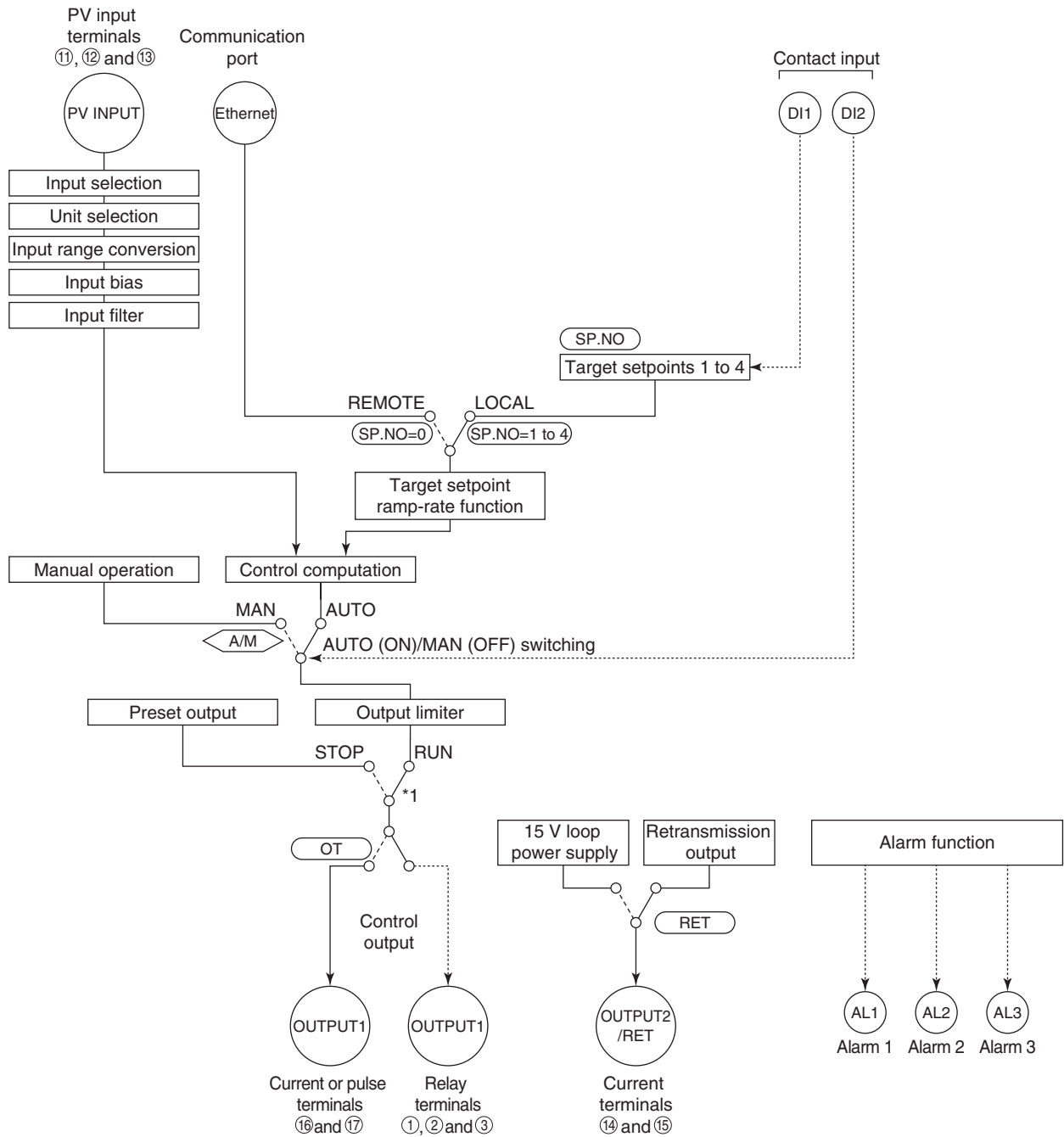

*1: If the setup parameter DIS (DI function selection) is set to "4", when the contact input 2 is ON (stop state), that controller outputs the preset output value.

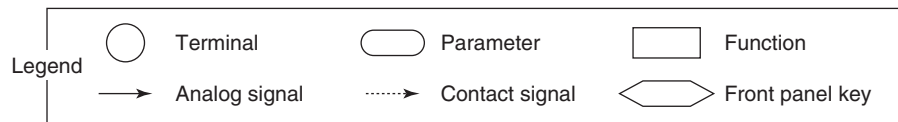

■ Function Block Diagram for Heating/Cooling Type

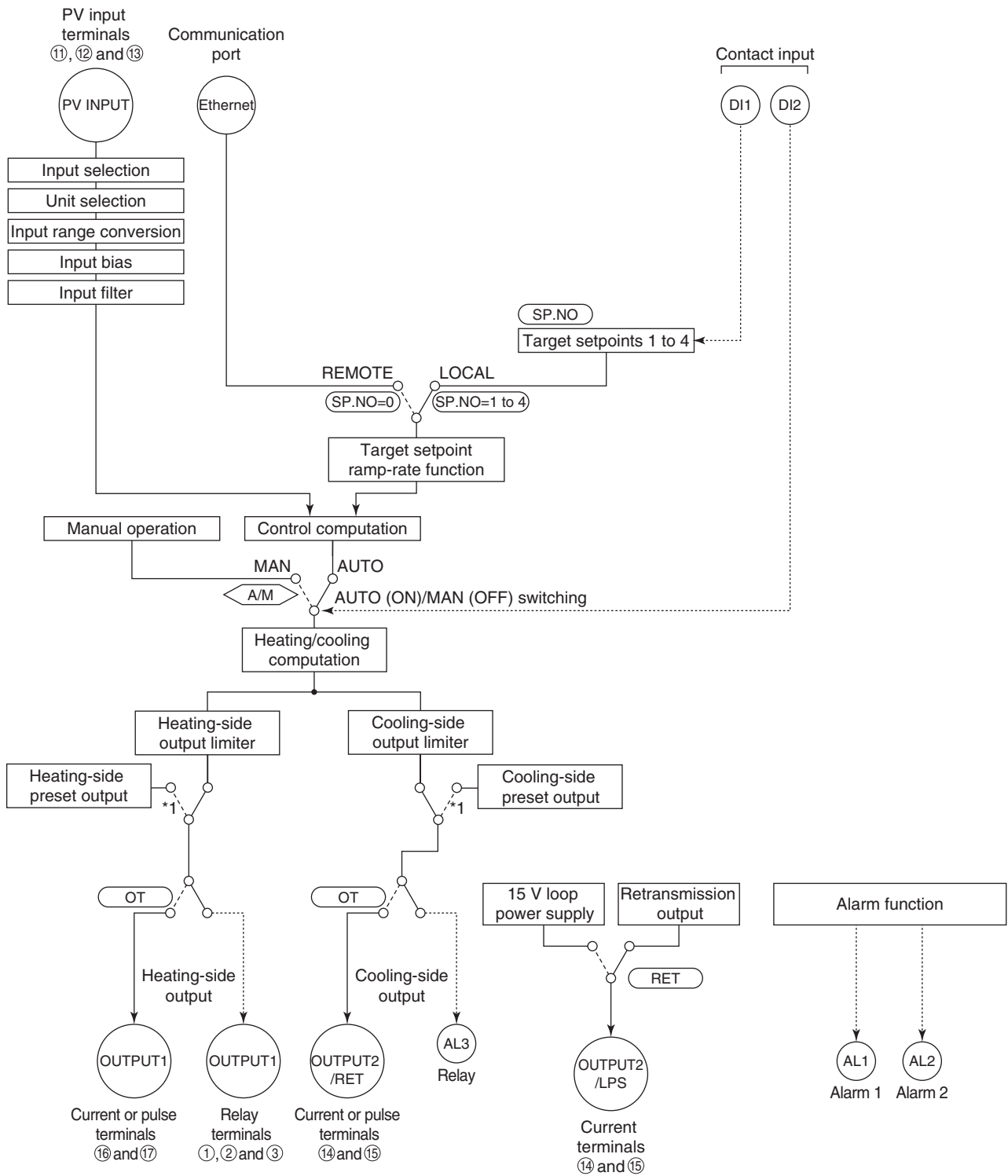

*1: If the setup parameter DIS (DI function selection) is set to "4", when the contact input 2 is ON (stop state), that controller outputs the preset output value.

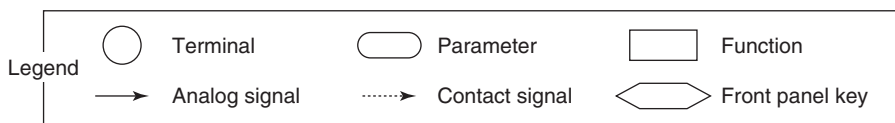

Functions and Parameters for “Standard Type” in Initial State (Factory-set default)

Functions and parameters in initial state are given in the tables below. For details on each parameter, refer to “5.2 Lists of Parameters.”

■ PV Input

PV input (INPUT) is a universal input, which can receive signals from thermocouple, RTD, or DC voltage signals. The controller is capable of biasing, and first-order lag computation (filtering) on input signals.

Each function can be set by the following parameters.

Setup Parameters

Function	Parameter	Menu
Input selection	IN	I/O
Unit selection	UNIT	I/O
Input range conversion	RH, RL (SDP, SH, SL)	I/O

Operating Parameters

Function	Parameter	Menu
PV input bias	BS	OP.PA
PV input filter	FL	OP.PA

■ Remote Input

Remote input can be received via communication. Set “0” in the parameter SP.NO (target setpoint number selection) for remote input. For more information, refer to Ethernet Communication Functions (IM 05G01B52-01E).

Each function can be set by the following parameters.

Operating Parameters

Function	Parameter	Menu
Target setpoint number selection	SP.NO	OP.PA

■ Contact Input

Changing the setpoint of the parameter DIS (DI function selection) allows you to change the function of contact input.

● When DIS=OFF

No function for contact input.

● When DIS=1 (factory-set default)

Target setpoint 2 (ON)/Target setpoint 1 (OFF) switching function is assigned to DI1 (contact input 1).

Automatic (ON)/Manual (OFF) switching function is assigned to DI2 (contact input 2).

Manipulated output can be changed using the  and  keys in manual mode.

● When DIS=2

Hide (ON)/Show (OFF) the parameter LOCK (key lock) switching function is assigned to DI1 (contact input 1).

No function is assigned to DI2 (contact input 2).

● When DIS=3

It is possible to select one out of four setpoints by turning the two contact input signals ON or OFF. This function is assigned to DI1 (contact input 1) and DI2 (contact input 2).

Contact input	Target setpoint number to be selected (SP.NO)			
	1	2	3	4
DI1	OFF	ON	OFF	ON
DI2	OFF	OFF	ON	ON

For example, set contact input 1 (DI1) only to "ON" to change target setpoint 1 to 2. Set contact inputs 1 (DI1) and 2 (DI2) to "ON" to select target setpoint 4.

● When DIS=4

Target setpoint 2 (ON)/Target setpoint 1 (OFF) switching function is assigned to DI1 (contact input 1).

Run (OFF)/Stop (ON) switching function is assigned to DI2 (contact input 2). Preset output value is output when the operation is stopped. PV input and alarms remain functioning as normal.

■ Target Setpoint and PID

It is possible to use a maximum of four groups of target setpoints and PID parameters. The target setpoint can be selected by key operation or contact input. For selection by contact input, refer to "Contact Input."

Operating Parameters

Function	Parameter	Menu
Target setpoint number selection	SP.NO	OP.PA
Target setpoints 1 to 4	n.SP	OP.PA
Proportional band (P)	n.P	OP.PA
Integral time (I)	n.I	OP.PA
Derivative time (D)	n.D	OP.PA

Note: Parameters n.SP, n.P, n.I, n.D (n=1 to 4) correspond to the target setpoint number selected in the target setpoint number selection (SP.NO).

The target setpoint ramp rate setting function prevents the target setpoint from changing suddenly. It is possible to set the upward and downward changing rate (i.e., ramp rate) independently in the parameters UPR and DNR. The unit of the ramp rate (hour, or minute) is specified in TMU.

Setup Parameters

Function	Parameter	Menu
Ramp-rate time unit setting	TMU	FUNC

Operating Parameters

Function	Parameter	Menu
Target setpoint ramp-rate setting	UPR, DNR	OP.PA

■ Control Output

Control output (OUTPUT1) selects the output type among the current output, voltage pulse output, and relay contact output signal.

Preset output value is output when the operation is stopped by key operation or contact input, which takes priority over the manual operation.

Each function can be set by the following parameters.

Setup Parameters

Function	Parameter	Menu
Control output type selection	OT	I/O
Control output cycle time	CT	FUNC
Preset output	PO	FUNC

Operating Parameters

Function	Parameter	Menu
Output limiter	OL, OH	OP.PA

■ Contact Output

Alarm 1 is output via DO1 (contact output 1).

Alarm 2 is output via DO2 (contact output 2).

Alarm 3 is output via DO3 (contact output 3).

Setup Parameters

Function	Parameter	Menu
Alarm 1 type	AL1	FUNC
Alarm 2 type	AL2	FUNC
Alarm 3 type	AL3	FUNC

Operating Parameters

Function	Parameter	Menu
Alarm 1 setpoint	A1	OP.PA
Alarm 2 setpoint	A2	OP.PA
Alarm 3 setpoint	A3	OP.PA

■ Retransmission Output

PV, target setpoint, or control output can be output to retransmission output (OUTPUT2/RET).

Each function can be set by the following parameters.

Setup Parameters

Function	Parameter	Menu
Retransmission output type	RET	I/O
Retransmission output scale	RTH, RTL	I/O

■ 15 V DC Loop Power Supply

The 15 V DC loop power supply (OUTPUT2/RET) uses the same terminal as retransmission output. The 15 V DC loop power supply can not be used when retransmission output is used. To use the 15 V DC loop power supply, set “4” in retransmission output type selection parameter RET.

Each function can be set by the following parameters.

Setup Parameters

Function	Parameter	Menu
Retransmission output type	RET	I/O

Revision Information

- Title : Model UT351 Digital Indicating Controller User's Manual
- Manual No. : IM 05D01D13-41E

Jul. 2004/1st Edition

Newly published

Sep. 2004/2nd Edition

Approved by UL508 and addition of the parameter PRI

Mar. 2005/3rd Edition

Addition of alarm function.

May 2006/4th Edition

Addition of explanation for the parameter indication

Written by Yokogawa Electric Corporation

Published by Yokogawa Electric Corporation
2-9-32 Nakacho, Musashino-shi, Tokyo 180-8750, JAPAN

Blank Page

YOKOGAWA

Yokogawa Electric Corporation

YOKOGAWA ELECTRIC CORPORATION

Network Solutions Business Division

2-9-32, Nakacho, Musashino-shi, Tokyo, 180-8750 JAPAN

Phone: +81-422-52-7179 Facsimile: +81-422-52-6793

Sales Branch Offices

Tokyo, Nagoya, Osaka, Hiroshima, Fukuoka

YOKOGAWA CORPORATION OF AMERICA

Headquarters

2 Dart Road, Newnan, GA. 30265-1094 U.S.A.

Phone: +1-770-253-7000 Facsimile: +1-770-251-0928

Sales Branch Offices / Texas, Chicago, Detroit, San Jose

YOKOGAWA EUROPE B. V.

Headquarters

Databankweg 20, 3821 AL Amersfoort THE NETHERLANDS

Phone: +31-334-64-1611 Facsimile: +31-334-64-1610

Sales Branch Offices / Houten (The Netherlands), Wien (Austria), Zaventem (Belgium), Ratingen (Germany), Madrid (Spain), Bratislava (Slovakia), Runcorn (United Kingdom), Milano (Italy), Vélizy villacoublay(France), Johannesburg(Republic of South Africa)

YOKOGAWA AMERICA DO SUL S.A.

Headquarters & Plant

Praca Acapulco, 31-Santo Amaro, Sao Paulo/SP, BRAZIL CEP-04675-190

Phone: +55-11-5681-2400 Facsimile: +55-11-5681-4434

YOKOGAWA ENGINEERING ASIA PTE. LTD.

Head office

5 Bedok South Road, Singapore 469270 SINGAPORE

Phone: +65-6241-9933 Facsimile: +65-6241-2606

YOKOGAWA ELECTRIC KOREA CO., LTD.

Seoul Sales office

395-70, Shindaebang-dong, Dongjak-gu, Seoul,156-010, KOREA

Phone: +82-2-3284-3000 Facsimile: +82-2-3284-3019

YOKOGAWA TAIWAN CORPORATION

Head office

17F, No.39, Sec. 1, Chung Hwa Road Taipei, 100 TAIWAN

Phone: +886-2-2314-9166 Facsimile: +886-2-2314-9918

YOKOGAWA AUSTRALIA PTY. LTD.

Head office

CentreCourt D1, 25-27 Paul Street North, North Ryde, N. S. W. 2113, AUSTRALIA

Phone: +61-2-9805-0699 Facsimile: +61-2-9888-1844

YOKOGAWA INDIA LTD.

Head office

40/4 Lavelle Road, Bangalore, 560 001, INDIA

Phone: +91-80-227-1513 Facsimile: +91-80-227-4270

LTD. YOKOGAWA ELECTRIC

Grokholskiy per. 13, Build. 2, 4th Floor, 129010, Moscow, RUSSIA FEDERATION

Phone: +7-095-737-7868 Facsimile: +7-095-737-7869
